

# SERVICE INSTRUCTIONS

SPLIT TYPE ROOM  
AIR CONDITIONER

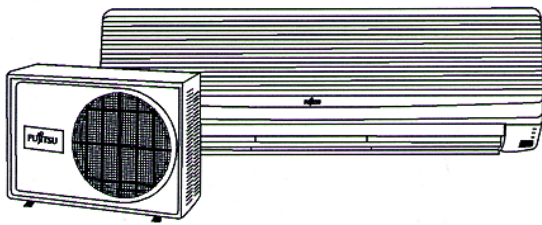

WALL MOUNTED  
COMPACT-L2 type

9,000 BTU/h

12,000 BTU/h

WIRELESS REMOTE  
CONTROL MODEL

## CONTENTS

DIMENSIONS .....	1
DESCRIPTION OF FUNCTIONS .....	.2
DEFROSTING OPERATION FLOW CHART .....	11
TROUBLESHOOTING GUIDE .....	.12

# DIMENSIONS

9000, 12000 BTU / h Models

## 1. INDOOR UNIT

Unit : in

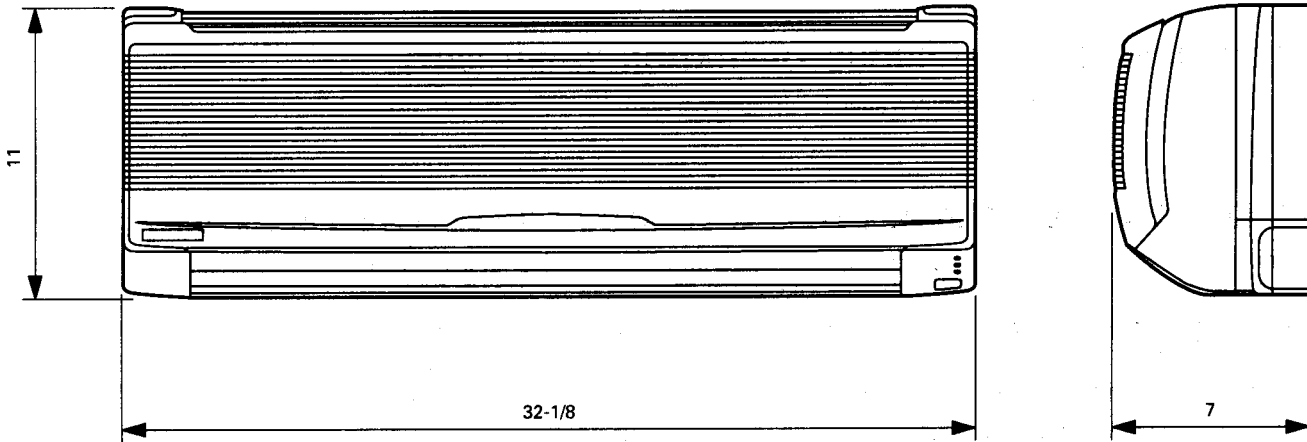

## 2. OUTDOOR UNIT

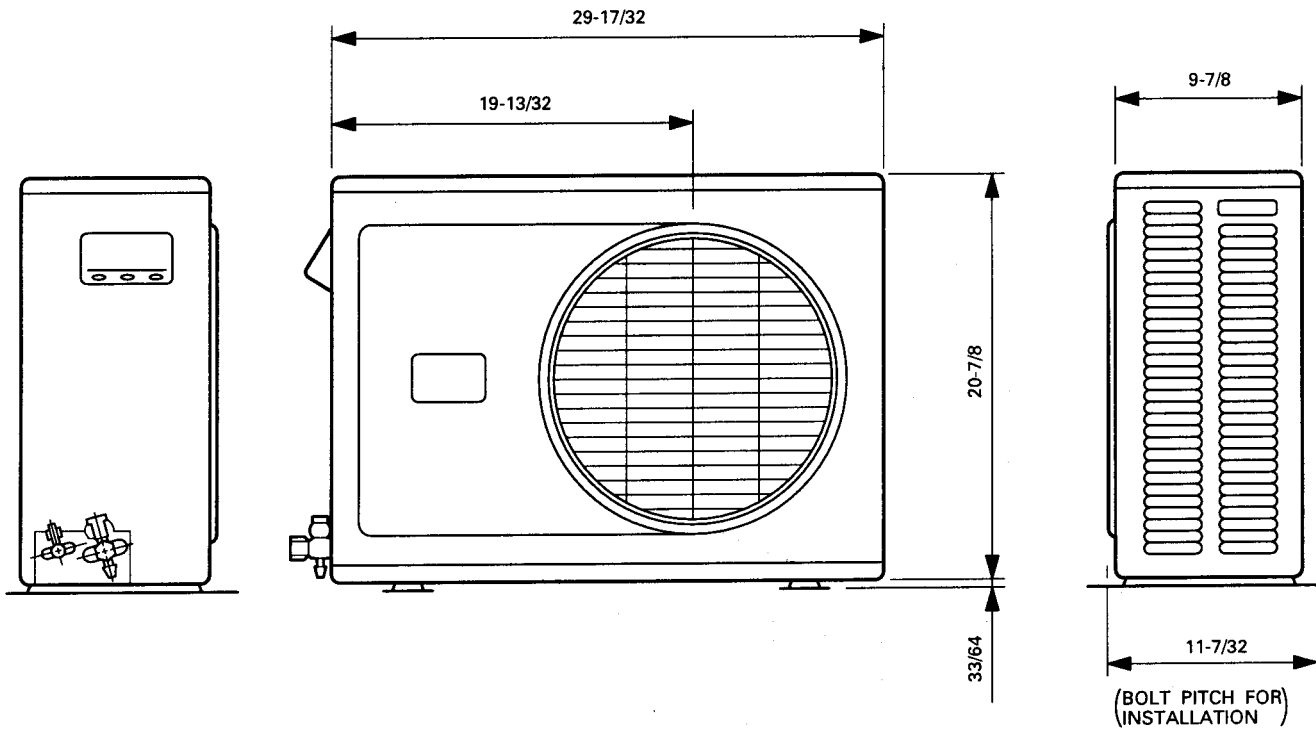

# DESCRIPTION OF FUNCTIONS

## 1. THREE MINUTES DELAY FUNCTION (3ST)

- (1) The outdoor unit does not operate for three minutes after the power switch is turned on. (Compressor protection, breaker off prevention, etc.)
- (2) When test operation is performed in heating during continuous operation, it takes some time until air blows out of the indoor unit because "Three minutes delay" and "Cold air prevention" have priority over TEST operation.

## 2. THREE MINUTES CONTINUOUS OPERATION TIMER (3HT)

The unit continues to run for three minutes after the compressor starts.

## 3. INDOOR HEAT EXCHANGER DE-ICING FUNCTION (Cooling & dry operations)

- (1) When the indoor unit heat exchanger temperature drops to "Temperature I" or less, the outdoor unit fan motor operates intermittently at a 15 seconds ON/12 seconds OFF cycle. (Starts from 12 seconds OFF.)
- (2) When the indoor unit heat exchanger temperature reaches "Temperature II" or more, outdoor unit fan motor intermittent operation stops.  
(However, the fan motor does not operate for 12 seconds after it stops at (1) above.)
- (3) When the indoor unit heat exchanger temperature reaches "Temperature III" or less after the outdoor unit fan motor was intermittently operated by (1) above, the outdoor unit fan motor and compressor stop.  
However, when the 3 minutes HT was running, the 3 minutes HT has priority.
- (4) When the outdoor unit fan motor and compressor were stopped by (3) above, "3 minutes ST" starts simultaneously with stopping of the compressor. Thereafter, the compressor and outdoor unit fan remain stopped until the indoor unit heat exchanger temperature reaches "Temperature I" or more after "3 minutes ST" time-out, and operation returns to normal operation when "Temperature II" or more was reached.
- (5) The indoor unit fan motor operates in accordance with the set air flow even while the freezing protection function is operating.  
However, during dry operation, "1 minute ON / 3 minutes OFF" intermittent operation is performed while the compressor is stopped by (3) above.
- (6) The "Temperature I, II, III" values are shown below.

	Temperature I	Temperature II	Temperature III
Hi	8 °F	12 °F	4 °F
Me	8 °F	12 °F	4 °F
Lo	8 °F	12 °F	4 °F
Quiet	8 °F	26 °F	4 °F
Dry	8 °F	26 °F	4 °F

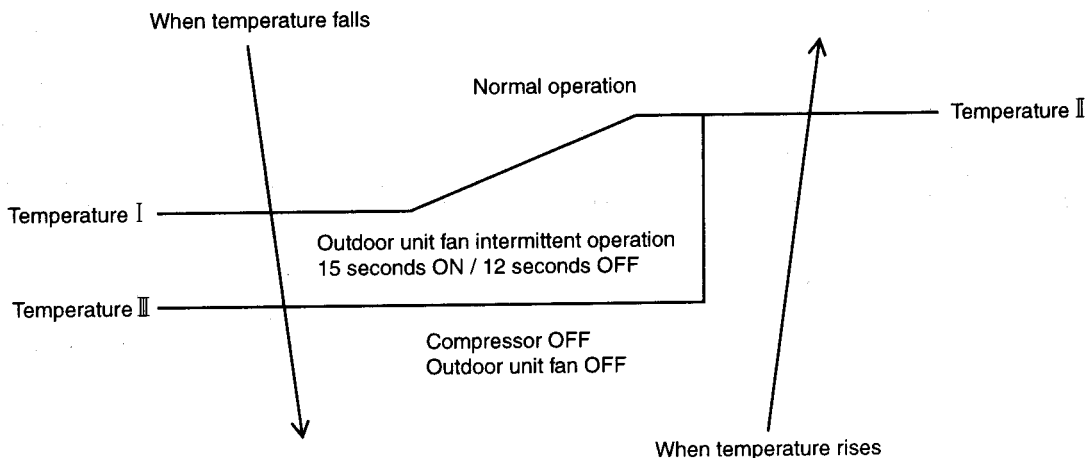

#### **4. DEFROSTING OPERATION [REVERSE CYCLE] See Defrosting Flow Chart on Page 14.**

- (1) The defrosting operation is performed when frost is produced on the outdoor heat exchanger. At this time, the heating mode will stop temporarily.
- (2) The defrosting operation time differs with such conditions as temperature, humidity, etc. (Approximately 6 to 13 minutes)
- (3) During defrosting, both the indoor and outdoor fans stop and the operation lamp flashes.
- (4) "Bushhhh", "goh, goh, goh" and other sounds will be heard during defrosting. These sounds are normal. (Four-way valve switching sound, refrigerant sound)

#### **5. 4-WAY VALVE DELAY SWITCHING FUNCTION [REVERSE CYCLE]**

When the heating operation stops, the 4-way valve stops 3 minutes later.

#### **6. COLD AIR DISCHARGE PREVENTION FUNCTION [REVERSE CYCLE]**

- (1) When the heating operation starts, the indoor unit fan operates in the "S-Lo (Super-Low)" mode.  
After the temperature of the indoor heat exchanger rises above 81°F, operation enters to the specified airflow mode.
- (2) When the compressor is stopped by the thermostat, the indoor fan enters to the S-Lo mode about 15 seconds later.

#### **7. HEATING OVERLOAD PROTECTION FUNCTION [REVERSE CYCLE]**

During heating operation, the compressor operates, but the outdoor fan may stop.  
A function which suppresses the absorption of heat and protects the machine by stopping the outdoor fan when the indoor heat exchanger temperature has risen abnormally and the outdoor temperature is high is provided.

- (1) If the indoor unit heat exchanger temperature reaches "Temperature I" or more, the outdoor fan motor operates intermittently at a 2 seconds ON / 25 seconds OFF cycle.
- (2) When (1) above was performed by indoor unit heat exchanger temperature, "outdoor unit fan motor intermittent operation" is stopped when the indoor heat exchanger temperature drops to "Temperature II" or less.  
However, the outdoor unit fan motor does not operate for 25 seconds after being stopped by (1).
- (3) When the indoor unit heat exchanger temperature rises to "Temperature III" or more after the outdoor unit fan motor was intermittently operated by (1) above, the outdoor unit fan motor stops continuously.
- (4) When the indoor unit heat exchanger temperature reaches "Temperature IV" or less when the outdoor unit fan motor was stopped continuously by (3) above, the outdoor unit fan motor continuous stop is reset and the fan motor operates intermittently at a 2 seconds ON / 25 seconds OFF cycle.  
However, the outdoor unit fan motor does not operate for 25 seconds after continuously stopped by (3).
- (5) When the indoor unit heat exchanger temperature reaches "Temperature V" or more after the outdoor unit fan motor was continuously stopped by (3) above, the compressor stops.  
(This operation has priority over the 3 minutes hold timer (3 minutes HT).)

- (6) When the outdoor unit fan motor and compressor were stopped by (5), the "3 minutes ST" starts simultaneously with stopping of the compressor and at "3 minutes ST" time-out, "outdoor unit fan motor" and compressor" stop is reset.
- However, when the indoor unit heat exchanger temperature at the start of compressor operation satisfies conditions (1) to (4) above, outdoor unit fan motor performs operations (1) to (4) above.
- (7) The four way valve is not turned OFF even when the compressor is stopped by (5) above.
- (8) The "Temperature I, II, III, IV, V" values conform to the operation values table shown below.

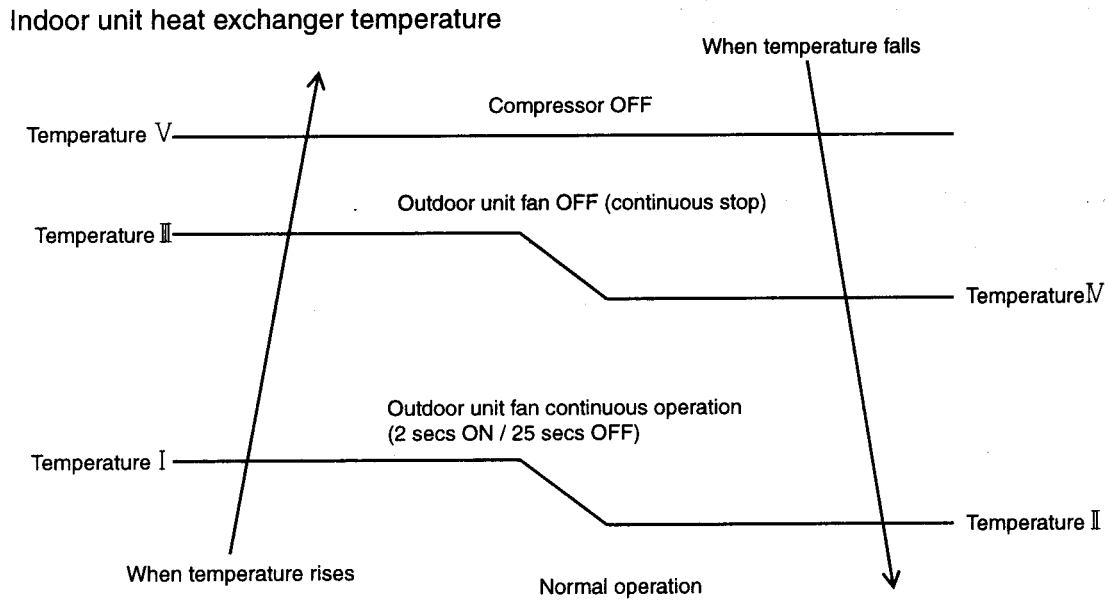

Models	Heating Overload Protection					
	Air flow ④ to ⑦					
	I	II	III	IV	V	
9R	Hi	53	50	58	56	62
	Me	53	50	58	56	62
	Lo	53	50	58	56	62
Heat & Cool	Quiet	53	50	58	56	62
12R	Hi	53	48	58	55	64
	Me	53	48	58	55	64
	Lo	53	48	58	55	64
Heat & Cool	Quiet	53	48	58	55	64

## 8. SET TEMPERATURE COMPENSATION AT OPERATION START

At the start of operation and when MASTER CONTROL is switched to cooling and heating, the set temperatures are compensated by +4°F for heating operation for 60 min. and by -2°F for cooling operation for 40 min.

## 9. OPERATION CONTROL PANEL AND REMOTE CONTROL UNIT BUTTON

### OPERATION CONTROL PANEL

#### ① MANUAL AUTO BUTTON

Use this button for temporary manual operation in the event that the remote control unit batteries die, or the remote control unit is lost. Operation is the same as MASTER CONTROL "AUTO" position. In order to halt operation, either push the forced automatic button again or turn the POWER SWITCH off.

### — Operation Control Panel —

Controls are located under the front panel.

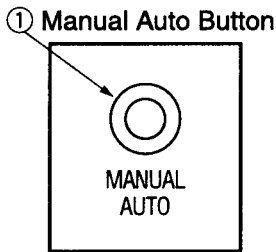

#### ② "TEST" BUTTON (TEST position)

- (1) When switched to the "TEST" position, only the thermostat is short-circuited.
- (2) Set to this position when testing after installation.
- (3) If the air conditioner is used in the "TEST" state, since the compressor, heat exchanger, etc. will be damaged because temperature control can not be performed, always switch to "NORMAL" operation.
- (4) If the microcomputer or other electronic circuit is faulty, the air conditioner can not be operated even by test run.
- (5) The "TEST" operation mode is released after 60 minutes and then the unit is set to "Normal" operation.

- ② TEST RUN button
- ③ ACL button
- ④ TIME ADJUSTMENT button
- ⑤ START/STOP button
- ⑥ MASTER CONTROL button
- ⑦ SET TEMP./SET TIME buttons
- ⑧ FAN CONTROL button
- ⑨ TIMER button
- ⑩ SLEEP button
- ⑪ AIRFLOW DIRECTION button
- ⑫ SWING LOUVER button
- ⑬ Signal Transmitter

### — Remote control unit —

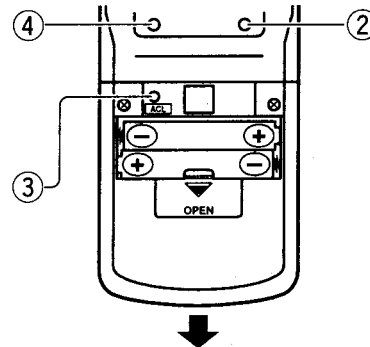
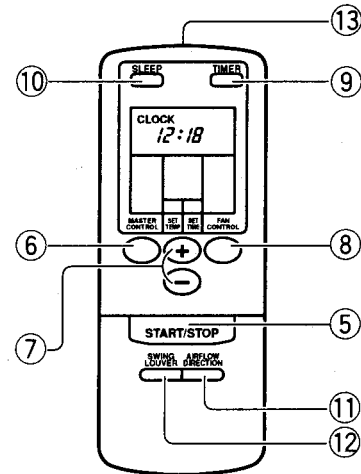

#### ③ "ACL" BUTTON

- (1) Press and slide the battery compartment lid on the reverse side to open it.
- (2) Insert batteries.
- (3) Press the ACL button.
- (4) Close the battery compartment lid.

NOTE : Never mix new batteries with used ones, or batteries of different types. Batteries will last about one year under normal use. If the remote control unit operating range becomes appreciably reduced, replace the batteries and press the ACL button with the tip of a ball-point pen or other small object.

#### ④ "TIME ADJUSTMENT" BUTTON

- (1) Press the TIME ADJUSTMENT button.
- (2) Use the +/- SET TIME buttons to adjust the clock to the current time.
- (3) Press the TIME ADJUSTMENT button again.

## ⑤ START/STOP AND ⑥ MASTER CONTROL BUTTONS

- Press the START/STOP button.  
The indoor unit operation indicator lamp (red) will light.  
The air conditioner will begin to operate.
- Press the MASTER CONTROL button to select the desired mode.  
Each time the button is pressed, the mode will change in the following order.



About three seconds later, the entire display will reappear.

## ⑦ SET TEMP. / SET TIME BUTTONS

- Press the SET TEMP. buttons
  - ⊕ button : Press to raise the thermostat setting.
  - ⊖ button : Press to lower the thermostat setting.
- Thermostat setting range :
  - Heating..... 60°F to 88°F
  - Cooling / Drying ..... 64°F to 88°F
 About three seconds later, the entire display will reappear.

### NOTE:

- During Fan mode, set the unit to “-” for continuous fan operation regardless of room temperature.

The thermostat setting should be considered a standard value, and may differ somewhat from the actual room temperature.

## ⑧ FAN CONTROL BUTTON

- Press the FAN CONTROL button.  
Each time the button is pressed, the fan speed changes in the following order:

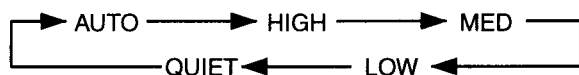

About three seconds later, the entire display will reappear.

When set to AUTO:

- Heating:** Fan operates so as to be optimally warm the air.  
However, the fan will operate at very low speed when the temperature of the air issued from the indoor unit is low.
- Cooling:** As the room temperature approaches that of the thermostat setting, the fan speed becomes slower.
- Fan:** The fan alternately turns on and off; when on, the fan runs at a low speed.

The fan will operate at very low setting during Monitor operation and at the start of the Heating mode.

## ⑨ TIMER BUTTON

### (A) To use the ON timer or OFF timer

- Press the START/STOP button (if the unit is already operating, proceed to step 2).  
The indoor unit operation indicator lamp (red) will light.
- Press the TIMER button to select ON timer or OFF timer operation.  
Each time the button is pressed the timer function changes in the following order:

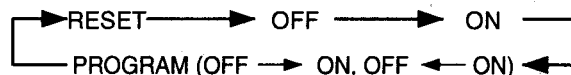

The indoor unit TIMER indicator lamp (green) will light.

- Use the SET TIME button to adjust the desired OFF time or ON time.  
Set the time while the time display is flashing (the flashing will continue for about five seconds).

- ⊕ button: Press to advance the time.
- ⊖ button: Press to reverse the time.

About five seconds later, the entire display will reappear.

### (B) To Use the Program timer

- Press the START/STOP button (if the unit is already operating, proceed to step 2).  
The indoor unit operation indicator lamp (red) will light.
- Set the desired times for OFF timer and ON timer.  
See the section “To Use the ON timer or OFF timer” to set the desired mode and times.  
About three seconds later, the entire display will reappear.  
The indoor unit timer indicator lamp (green) will light.
- Press the timer button to select the PROGRAM timer operation (either OFF → ON or OFF ← ON will display).

The display will alternately show “Off timer” and “On timer”, then change to show the time setting for the operation to occur first.

The PROGRAM timer will begin operation (if the ON timer has been selected to operate first, the unit will stop operating at this point).

About five seconds later, the entire display will reappear.

## ⑩ SLEEP BUTTON

To Use the SLEEP timer

- While the air conditioner is operating or stopped, press the SLEEP button.  
The indoor unit operation indicator lamp (red) lights and the timer indicator lamp (green) lights.

To Change the Timer Settings

Press the SLEEP button once again and set the time using the SET TIME button.  
Set the time while the Timer Mode Display is flashing (the flashing will continue for about five seconds).

- ⊕ button: Press to advance the time.
- ⊖ button: Press to reverse the time.

About five seconds later, the entire display will reappear.

## ⑪ ADJUSTING THE DIRECTION OF AIR CIRCULATION

Vertical (up-down) direction of airflow is adjusted by pressing the Remote Control Unit's AIR FLOW DIRECTION button.

Horizontal (right-left) airflow direction is adjusted manually, by moving the Air Flow Direction Louvers.

Whenever making horizontal airflow adjustments, start air conditioner operation and be sure that the vertical air direction louvers are stopped.

### (A) Vertical Air Direction Adjustment

Press the AIR FLOW DIRECTION button.

Each time the button is pressed, the air direction range will change as follows:

Cooling/ Dry mode	① ↔ ② ↔ ③ ↔ ⑥) NOTE	
Heating mode	④ ↔ ⑤ ↔ ⑥ ↔ ⑦	
Fan mode	③ ↔ ② ↔ ① ↔ ⑦ ↔ ⑥ ↔ ⑤ ↔ ④	

- Use the air direction adjustments within the ranges shown above.
- The vertical airflow direction is set automatically as shown, in accordance with the type of operation selected.
  - During cooling/Dry mode : Horizontal flow ①
  - During Heating mode : Downward flow ⑥
- If you wish to select a different airflow direction, you may use the remote control unit's AIR FLOW DIRECTION button to choose a different setting.
- When the temperature of the air being blown out is low at the start of heating operation or during defrosting, the airflow direction temporarily becomes ⑦ to prevent cold air being blown onto the body.
- When the AIR FLOW DIRECTION button of the remote control unit is pressed, some time is required until the airflow direction louvers reach the desired position. During this time, adjustment of the airflow direction is not possible even when the AIR FLOW DIRECTION button is pressed.

#### NOTE

During the cooling mode operation, you can select the air direction ①, ②, ③, or ⑥ (downward) by pressing the AIR FLOW DIRECTION button.  
Use the air direction ⑥ when you want to cool yourself for a while after taking a bath or shower, or after coming back home in summer months.  
But, for prevention of condensation on the louver, the air direction ⑥ is automatically released after 30 minutes and turned to the air direction ③.

### (B) Right-Left Adjustment

Adjust the Right-Left Louvers

- Move the Right-Left Louvers to adjust air flow in the direction you prefer.

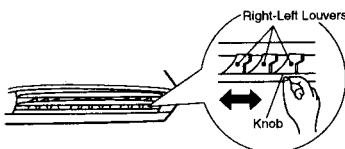

## ⚠ CAUTION

- Never place fingers or foreign objects inside the outlet ports, since the internal fan operates at high speed and could cause personal injury.

- Always use the remote control unit's AIR FLOW DIRECTION button to adjust the vertical airflow louvers. Attempting to move them manually could result in improper operation; in this case, stop operation and restart. The louvers should begin to operate properly again.
- When used in a room with infants, children, elderly or sick persons, the air direction and room temperature should be considered carefully when making settings.
- Always operate the Air Flow Direction Louvers and the Power Diffuser with the air flow direction buttons on the remote control. Forcible movement by hand can cause incorrect operation. In such a case, stop the operation to let the unit return to normal condition.
- Do not set the Air Flow Direction Louvers and the Power Diffuser for a long time to the heating mode (⑦) during cooling or drying operation. This can cause condensation at the discharge opening and dripping of water. (When operation is continued for 30 minutes or more in the heating mode ⑤ ⑥ ⑦, automatic return will be made to the direction ④.)

## ⑫ SWING OPERATION

Begin air conditioner operation before performing this procedure.

### To Select SWING Operation

Press the SWING LOUVER button.

The SWING Indicator Lamp (orange) will light.

In this mode, the Air Flow Direction Louvers will swing automatically to direct the airflow both up and down

### To Stop SWING Operation

Press the SWING LOUVER button once again.

The SWING Indicator Lamp (orange) will go out.  
Airflow direction will return to the setting before swing was begun.

### About Swing Operation

- The SWING range is as follows:

Cooling/ Dry mode	① ↔ ③, (④ ↔ ⑦) NOTE	
Heating mode	④ ↔ ⑦	

- The SWING operation may stop temporarily when the air conditioner's fan is not operating or when operating at very low speeds.
- The airflow direction can not be adjusted during SWING operation even when the AIR FLOW DIRECTION button is pressed.

#### NOTE

During the cooling mode operation, the air swings between ④ and ⑦ by pressing the SWING LOUVER button after selecting the air direction ⑥ (downward) by pressing the AIR FLOW DIRECTION button.  
Use this operation when you want to cool yourself for a while after taking a bath or shower, or after coming back home in summer months.  
But, for prevention of condensation on the louver, the swing of the air direction ④ ↔ ⑦ is automatically released after 30 minutes and turned to the swing of the air direction ① ↔ ③.

## 10. TIMER

There are four timer modes: "SLEEP", "OFF TIMER", "ON TIMER" and "PROGRAM TIMER".

- (1) Set the clock time when the unit is in the stop mode (only the current time will be shown on the remote control unit display).
- (2) While adjusting the current clock time, do not use other remote control functions.
- (3) Each time the TIMER button is pressed, the remote control unit display will change in order shown below:

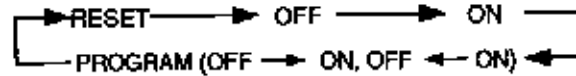

### ① SLEEP timer

When desiring to stop operation automatically after you go to bed, if the SLEEP button is pressed, operation stops while the "room temperature" is changed automatically.

#### • Cooling/Drying

When set to "SLEEP", the set temperature is raised 2°F, then raised 2°F / 1 hour thereafter. When the temperature has been raised a total of 4°F, that temperature is held until the set time has elapsed, then operation automatically stops.

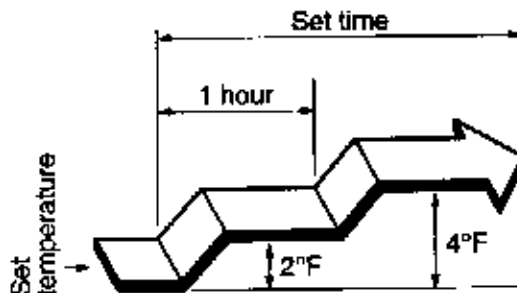

#### • Heating [REVERSE CYCLE]

When set to "SLEEP", the set temperature is lowered 2°F, then lowered 2°F / 30 minutes thereafter. When the temperature has been lowered a total of 8°F, that temperature is held until the set time has elapsed, then operation automatically stops.

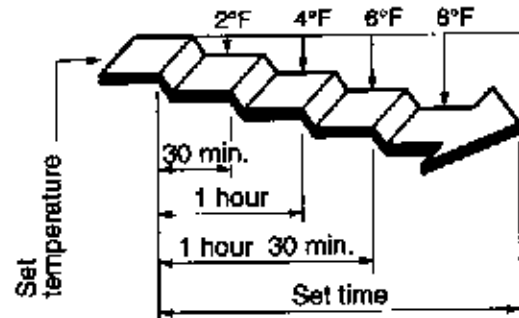

### ② OFF TIMER

Use when going to bed or otherwise to stop operation. When the clock reaches the set time, the air conditioner will be turned off.

### ③ ON TIMER

Four wake-up operation or otherwise to start operation. Depending on the difference between the actual room temperature and the set temperature, the unit will start operation automatically in order to bring the room temperature to the desired set temperature by the time previously set.

The higher or lower the room temperature (relative to the set temperature), the earlier the unit will start to operate. ON-timer operation will start:  
 For heating: 45 to 10 minutes before the set time  
 For cooling: 20 to 10 minutes before the set time

In the FAN mode, operation will start precisely at the set time.

### ④ PROGRAM TIMER

The PROGRAM timer allows you to integrate OFF timer and ON timer operations in a single sequence. The sequence can involve one transition from OFF timer to ON timer, or from ON timer to OFF timer, within a twenty-four hour period.

The first timer function to operate will be the one set nearest to the current time.

The order of operation is indicated by the arrow in the Remote Control Unit display (OFF → ON, or OFF ← ON).

One example of PROGRAM timer use might be to have the air conditioner automatically stop (OFF timer) after you go to sleep, then start (ON timer) automatically in the morning before you arise.

## 11. FAN CONTROL

### (A) "AUTO" POSITION

#### (1) COOLING OPERATION

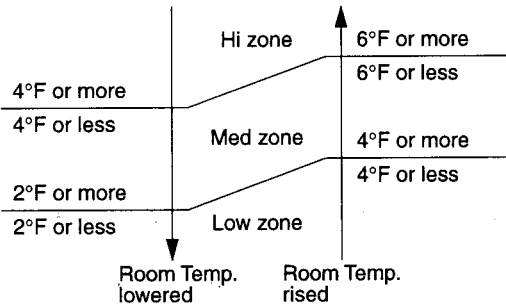

Airflow mode is set automatically in accordance with the condition "(Room temp. - Set temp.)" as shown at the left.

#### (2) HEATING OPERATION

- (1) When the indoor heat exchanger temperature reaches 116°F or more, the fan mode switches to the next higher position. ("LOW" → "MED", "MED" → "HIGH")
- (2) When the indoor heat exchanger temperature drops below 106°F while the compressor operates, the fan mode switches to the next lower position. ("HIGH" → "MED", "MED" → "LOW")
- (3) After switching the fan mode, it does not switch again within 2 minutes.
- (4) When "FAN CONTROL" is switched to "AUTO" while the unit is operated at the "FAN CONTROL" position of "HIGH", "MED" or "LOW", the unit operates in the "MED" fan mode at a room temperature of more than 106°F and in the "LOW" fan mode at a room temperature of less than 106°F.

### (B) "LOW", "MED" and "HIGH" position

The indoor fan operates at the airflow set in the FAN CONTROL mode.

### (C) QUIET position

Quiet operation begins. The indoor unit airflow will be reduced for quieter operation. Quiet operation cannot be used during Dry mode. (In the same way, when the dry mode is selected during AUTO mode operation, SUPER QUIET operation cannot be used.)

During Super Quiet operation, heating and cooling performance will be reduced somewhat.

## 12. OPERATING MODES

### (1) "AUTO" position

Depending on the room temperature when operation begins, the operating mode will be switched automatically as shown in the accompanying table. Also, depending on the operating mode, the room temperature setting will cause the "standard" temperature to be set as shown.

Mode	Standard temperature			Thermostat temperature setting range
Auto	Room Temperature	Operating Mode	Temperature Setting (standard)	Standard temperature setting ± 4 °F
	88°F or more	⇒ Cool	⇒ 82 °F	
	82°F to 88°F	⇒ Cool	⇒ 80 °F	
	76°F to 82°F	⇒ Dry	⇒ 76 °F	
	72°F to 76°F	⇒ Monitor		
Less than 72°F	⇒ Heat	⇒ 74 °F		
Heating	_____			60 °F to 88 °F
Cooling / Dry	_____			64 °F to 88 °F

- ① Once the operating mode has been set, it will not change even if the room temperature changes. However, in the monitor operation mode, when the room temperature drops to below 72°F, the mode will automatically switch to heating, and when it rises above 75°F, the mode will automatically switch to drying.
- ② In the monitor mode, the fan will operate very slowly (S-Low mode).

- ③ In the dry mode, the fan will operate slowly to prevent the room humidity from rising, and the room fan may stop.
- ④ During defrosting operation in the heating mode, the OPERATION indicator lamp will flash slowly and the heating mode will stop temporarily.

**(2) "FAN" position:**

- ① In this position, the fan operates alone to circulate air. The room temperature will not be changed.
- ② Operates at the airflow set in the FAN CONTROL mode.

**(3) "DRY" position**

- ① In the dry mode, since preference will be given to remove humidity, the room temperature may not be lowered to the selected value.
- ② When using the dry mode, set the temperature to a value lower than the current room temperature. If it is set higher than the current room temperature, the unit will not enter the dry mode.
- ③ Room heating cannot be performed in the dry mode.
- ④ In the dry mode, the optimum fan speed will be set automatically and cannot be changed. The fan will emit a very weak stream of air.
- ⑤ In the dry mode, the room fan may occasionally stop in order to prevent the room humidity from rising.

**(4) "COOL" position**

When using the cooling mode, set the temperature to a value lower than the current room temperature. If it is set higher than the current room temperature, the unit will not enter the cooling mode and only the fan will operate.

**(5) "HEAT" position [REVERSE CYCLE]**

- ① Set the temperature higher than the current room temperature. If it is set to a lower temperature, heating will not start.
- ② For about 3 to 5 minutes after the start of heating, the fan will operate very slowly, then switch to the selected fan setting. This period allows the indoor unit heat exchanger to warm-up before emitting warm air.
- ③ During defrosting, the OPERATION indicator lamp will flash slowly, and the heating mode will be temporarily interrupted.

### 13. AUTO RESTART

The air conditioner power has been interrupted by a power failure. When the power is restored, the air conditioner will then restart automatically in its previous mode.

Operated by setting before the power failure. Then the airflow direction louvers will automatically change to their standard direction.

If a power failure occurs during TIMER operation, the timer will be reset and the unit will begin (or stop) to operate at the new time setting. If this kind of timer fault occurs, the TIMER indicator lamp (green) will flash.

Use of other electrical appliances (electric shaver, etc.) or nearby use of a radio transmitter may cause the air conditioner to malfunction. In this event, temporarily disconnect the power supply plug, reconnect it, and then use the power control unit to resume operation.

### 14. PROTECTING THE FAN MOTOR BY LOCKING

When the indoor fan motor starts, or the fan control mode is changed, the indoor fan motor detects the number of revolutions in 56 seconds.

When the indoor fan motor shows the unusual revolutions, it then stops.

# DEFROSTING OPERATION FLOW CHART (REVERSE CYCLE)

## DEFROSTING (Only at "Heating" flow chart)

### Meaning of symbols

O.L.P. (Overload Protector) is operating: If the indoor heat exchanger temperature is too high, the outdoor fan is stopped to prevent the former from rising.

T<sub>c</sub> : Indoor heat exchanger temperature (Indoor pipe thermistor detector)

T<sub>r</sub> : Room temperature (Room thermistor detector)

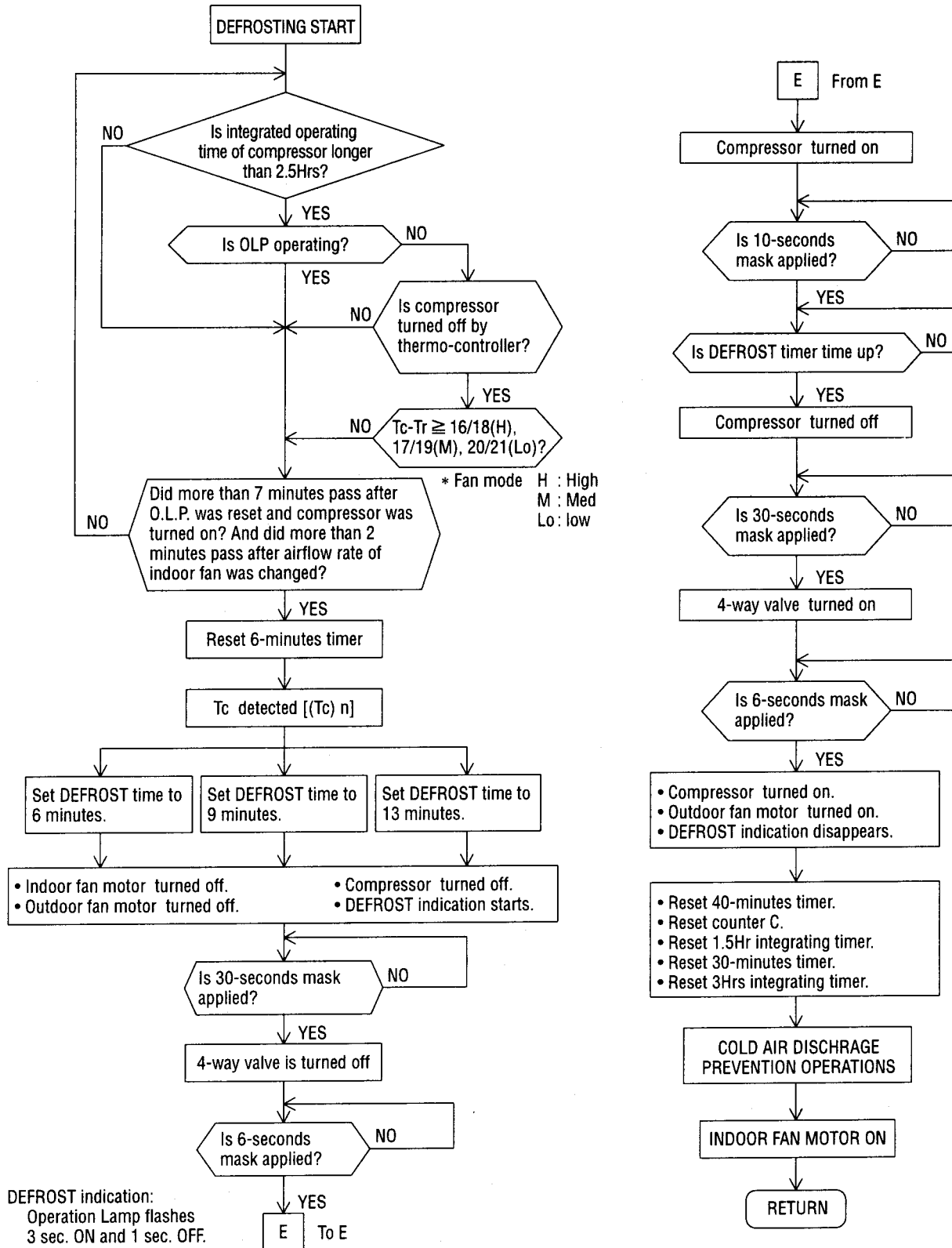

# TROUBLESHOOTING GUIDE

## 1. WORKING INSPECTION (When cooling)

Symptom	Possible causes	Remedy
(1) Indoor unit evaporator is covered with frost. a. Frost near inlet. b. Frost all over	Gas leakage Clogged filter Low ambient temperature (less than 68°F)	Check the leaking part, and charge gas. Clean the filter. Check the ambient temperature.
(2) Compressor operates, but does not cool.	Dirty condenser	Clean.
(3) Water does not come out of the drain hose.	When the compressor operates normally, the gas leaks.	Charge gas and replace the parts.
(4) Compressor return pipe (low pressure) is not cold.	Gas leakage	Charge gas. Replace the parts.
(5) Compressor outlet pipe (high pressure) is not hot.	Gas leakage	Charge gas.
(6) Compressor operates, but does not cool. a. Indoor unit evaporator is cold. b. Outdoor unit condenser is hot, it does not cool.	Overload operation  Dirty condenser	Eliminate overload.  Clean.
(7) Indoor unit air outlet temperature is low, but it does not cool.	Clogged filter The cooled air is short-circuited. Overload operation	Clean. Isolate the problem and correct. Eliminate the overload.

## 2. SYMPTOMS AND CHECK ITEMS

Symptom	Possible causes	Check item	Check points
No operation.	Power supply circuit faulty Microcomputer reset circuit faulty Remote control faulty External wiring receiving section faulty	Check 1  Check 2	Power supply circuit Microcomputer input signal Remote control troubleshooting
Erroneous operation. (Runaway)	Microcomputer runaway	Check 3	Reset circuit
Display does not light correctly.	Display unit faulty LED driver faulty	Check 4	Display unit Microcomputer output signal Driver output signal
Room temperature cannot be controlled.	Room thermistor faulty Pipe temperature thermistor faulty A/D converter input section faulty Compressor relay circuit faulty	Check 5 Check 8  Check 6	Thermistor resistance value  Microcomputer output signal Relay output
Room fan does not run and wind speed cannot be switched.	Wind speed relay faulty	Check 7	Microcomputer output signal Driver output signal
Indication panel abnormal	Thermistor short-circuited or opened	Check 9	Thermistor resistance value

## CHECK 1

Symptom--- No operation  
Remote control is not received.

### Preliminary checks

- \* Is the power cord plugged in?
- \* Is power present at the plug socket?
- \* Is power turned off?

### (1) Power connection check

- \* Is power received at power supply PCB terminal W103-104? (220 or 240V AC)
- \* Is the fuse (3.15A) blown?

### (2) Power transformer check

- \* Are CN104 and CN102 inserted firmly?
- \* Is 15 to 20V AC output at CN104?

### (3) Power supply circuit check

#### ① 12V line

0V D101, Q101 faulty  
D102, C107 short-circuited  
R101 open

#### ② 5V line

0V D103 open, IC102 faulty  
C109, C110 short-circuited.  
Other parts short-circuited.

### (4) Power interrupt signal faulty

R3, R5 open, IC2 faulty,  
C5 short-circuited.

### (5) Reset IC faulty

IC5 faulty.

### (6) Microcomputer oscillator faulty

Is the oscillator waveform (8.38 MHz) output at microcomputer pins 30 and 31?  
If the oscillation waveform is not output, X1 or the microcomputer is faulty.

### (7) Microcomputer faulty

## Check 2

### Preliminary checks

- \* If the air conditioner operates when the remote control battery is changed, there are no problems. (The battery life is six months to one year.)
- \* When the receiving part of the remote control unit is exposed to direct sunlight, the remote control receiver may not receive the signal.
- \* When the infrared signal between the remote control unit and receiver is blocked, the remote control receiver does not receive the signal.

### (1) Remote control unit check

If the signal tone is heard when a transistor radio is tuned to an unused frequency in the medium wave band and the remote control button is pressed within 5cm of the radio, the remote control unit is normal.

### (2) When the remote control unit is normal, is CN9 disconnected?

The receiver on the air conditioner switch PC board is faulty, or the main PC board is faulty.

## Check 3

Symptom--- Erroneous operation (Runaway)

### Preliminary checks

- \* Set the wall outlet to OFF and wait at least 30 seconds. Then, set the wall outlet to ON again. If remote control is received normally, there is no trouble.

### (1) Reset circuit faulty

IC5 faulty, C16 short-circuited

## Check 4

Symptom--- Display does not light correctly

### Preliminary checks

- \* Is display PC board connector CN4 inserted firmly?
- \* Is the display unit cable open?

### (1) LED driver faulty

IC3 faulty, R41 to R43 open. If all of the above are normal, the display unit is faulty.

## Check 5

Symptom--- Room temperature cannot be controlled.  
(Compressor does not run or does not stop.)

### Preliminary checks

- \* Is the TEST-MANUAL AUTO switch in the TEST position?

### TEST indication check

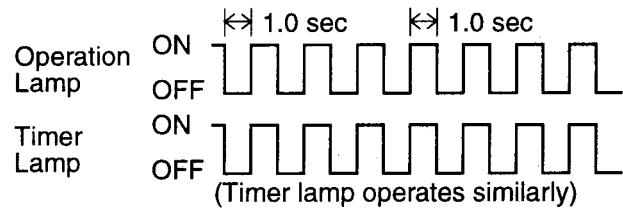

- \* Is room temperature or thermistor connector CN12 inserted firmly?

- \* Is the set temperature correct?

### (1) Thermistor faulty

The room temperature thermistor resistance values are shown on page 17.  
When there is a large error, the thermistor is faulty.

### (2) A/D input circuit faulty

R37 open or short-circuited, R34 open, C18 and C20 short-circuited. If all of the above are normal, advance to Check 6.

## Check 6

Symptom--- Room temperature cannot be controlled.

### Preliminary checks

- \* Is each Faston terminal of the power relay inserted firmly?
- \* Is the indoor unit and outdoor unit connection wiring open or loose?

### (1) IC3 faulty

IC3-11 output port short-circuited.  
Power relay faulty

## Check 7

Symptom--- Room fan does not run.

### Preliminary checks

- \* At dehumidification operation, the room fan is stopped while the compressor is stopped.
- \* Turn the fan once or twice by hand.  
If the fan does not turn easily, the fan motor is faulty.

### (1) Fan motor faulty

Fan motor winding open (check between all windings)

### (2) Fan motor capacitor faulty.

### (3) Relay drive circuit faulty

IC3 faulty  
IC3-12 output port short-circuited  
SSR101 faulty, L101 open

- (4) Protecting the indoor fan motor by locking  
 When the indoor fan will not run and the lamp is flashing on and off as shown in Fig.1, indoor fan motor protection by locking is functioning.  
 This function is released once by disconnecting the power plug.

**Check 8**

Room temperature thermistor

- \* CN2 disconnected. CN2 No.1-2 short-circuited.
- \* Thermistor faulty
- \* R37 open, short-circuited.
- \* C18, C20 short-circuited
- \* R33, R34 open.
- \* See Fig. 2 at the right.

Heat exchanger (Pipe) thermistor

- \* CN3 disconnected. CN3 No.1-2 short-circuited.
- \* Thermistor faulty
- \* R38 open, short-circuited.
- \* C19, C21 short-circuited.
- \* R35, R36 open.
- \* See Fig. 2 at the right.

**CHECK 9**

Thermistor Abnormal Indication

- (1) Whether during operation or non-operation, when the room temperature thermistor or heat exchanger thermistor is opened or short-circuited, operation is immediately stopped and failure indication (see item (3) described below) is displayed.
- (2) If this function stops the operation, any operation instruction cannot resume the operation.
- (3) Failure indications stated in (1) are shown in the Fig.2.

**3. Thermistor resistance values**

(1) Room temperature thermistor

<b>Room temperature (°F)</b>	37	41	46	50	59	68	77	84	89	91	97	104	111
<b>Resistance value (kΩ)</b>	28.7	25.9	22.3	20.1	15.8	12.5	10.0	8.4	7.7	7.0	6.2	5.3	4.5

(2) Heat exchanger (pipe) temperature thermistor

<b>Pipe temperature (°F)</b>	32	36	43	50	57	64	72	79
<b>Resistance value (kΩ)</b>	176.0	157.8	127.3	103.3	84.4	69.3	57.2	47.5
<b>Pipe temperature (°F)</b>	86	93	100	111	122	132	140	
<b>Resistance value (kΩ)</b>	39.6	33.2	27.9	21.7	17.0	13.5	11.6	

**Fig.1**

\* Protecting the indoor fan motor by locking.

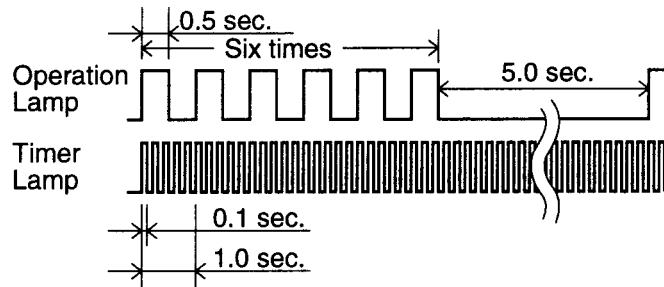

**Fig.2**

\* Room temperature thermistor and heat exchanger (pipe) thermistor are abnormal.

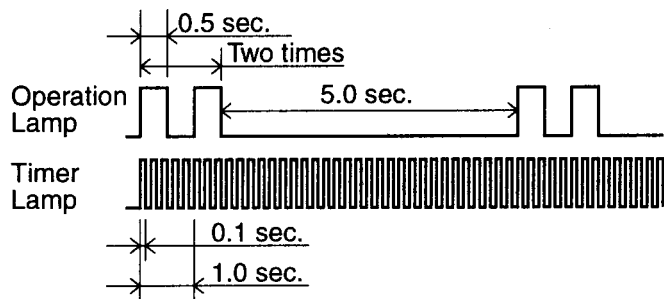



**FUJITSU GENERAL AMERICA, INC.**  
353 ROUTE 46W., FAIRFIELD, N.J. 07004  
Tel. (973) 575-0380