

FUJITSU

OPERATING MANUAL

ROOM AIR CONDITIONER

**MULTI SPLIT TYPE
(2 ROOMS)**

Indoor Unit
ASU12D

Outdoor Unit
AOU24D

COOLING MODEL

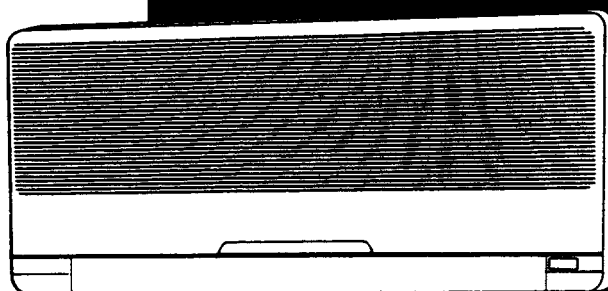

KEEP THIS OPERATION MANUAL
FOR FUTURE REFERENCE

FUJITSU GENERAL LIMITED



P/N9359526018

CONTENTS

PRECAUTIONS	2	TIMER OPERATION	18
NAME AND FUNCTION OF PARTS	6	PROGRAM TIMER	20
PREPARATION	10	SLEEP TIMER OPERATION	21
AUTOMATIC OPERATION	12	CARE AND MAINTENANCE	22
MODE OPERATION		OPERATION DETAILS	25
(COOL, DRY, FAN)	14	TROUBLE SHOOTING	26
AIR DIRECTION ADJUSTMENT	16		

PRECAUTIONS

- Before using the appliance, read these "PRECAUTIONS" thoroughly and operate in the correct way.
- The instructions in this section all relate to safety; be sure to maintain safe operating conditions.
- "CAUTION" and "WARNING" have the following meanings in these instructions:



 WARNING	This mark indicates procedures which, if improperly performed, might lead to the death or serious injury of the user.
 CAUTION	This mark indicates procedures which, if improperly performed, might possibly result in personal harm to the user, or damage to property.

Safety Symbols

 △ The triangular symbol indicates WARNING and CAUTION items.

 ⊘ This symbol indicates prohibited operations. The prohibited action is indicated both within the symbol, and in nearby explanations.

 ● This symbol indicates instructions regarding operations which are to be performed by the user.

⚠ DANGER	
<p>Do not attempt to install this air conditioner by yourself.</p> <ul style="list-style-type: none"> ● Consult authorized service personnel for all installations. 	
<p>Consult authorized service personnel for any repairs.</p> <ul style="list-style-type: none"> ● Do not attempt to remove parts, or service the unit yourself, since you may be exposed to dangerous electrical shock. This appliance contains no user-serviceable parts. 	
<p>When moving, consult authorized service personnel for disconnection and installation of the unit.</p>	

PRECAUTIONS



DANGER

Do not stay in direct cooling airflow for long periods.

- Excessive direct exposure to chilled air could be bad for your health.
- Be especially careful when going to bed, and in rooms where infants, aged, or sick people are staying.

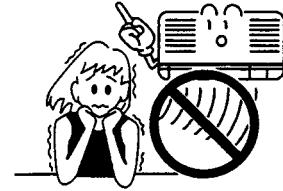

Do not insert fingers or objects into the outlet port or intake grilles.

- A fan operates at high speed inside the unit, and personal injury could result.
- Be particularly careful regarding small children.

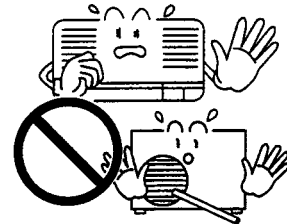

In the event of a malfunction (burning smell, etc.), immediately stop operation, disconnect the power, and consult authorized service personnel.

- Continuing to operate the unit under such conditions could lead to hazard of fire or electrical shock.



PRECAUTIONS



CAUTION

<p>Provide occasional ventilation during use.</p> <ul style="list-style-type: none"> ● Be careful to provide adequate ventilation particularly when using the unit in combination with other heating apparatus. ● Insufficient ventilation could lead to oxygen starvation. 	<p>Do not direct air flow at fireplaces or heating apparatuses.</p> <ul style="list-style-type: none"> ● Direct air blowing on fires could result in improper combustion or fire.
<p>Do not climb on, or place objects on, the air conditioner.</p> <ul style="list-style-type: none"> ● Personal injury could result from a falling object, or if the unit tips over. ● Do not hang on or cover the air conditioner. 	<p>Do not set flower vases or water containers on top of air conditioners.</p> <ul style="list-style-type: none"> ● Water leaking inside the unit could damage electrical insulation, leading to danger of electrical shock.
<p>Do not expose the air conditioner directly to water.</p> <ul style="list-style-type: none"> ● Electrical insulation could be damaged, resulting in electrical shock. 	<p>Do not operate the air conditioner with wet hands.</p> <ul style="list-style-type: none"> ● Electrical shock could result.
<p>Turn off power source when not using the unit for extended periods.</p>	<p>Always turn off power whenever cleaning the air conditioner or changing the air filter.</p> <ul style="list-style-type: none"> ● A fan operates at high speed inside the unit, and personal injury could result.
<p>Take precautions to prevent infants from accidentally swallowing batteries.</p> <ul style="list-style-type: none"> ● A battery can be very harmful if swallowed. If an infant accidentally swallows a battery, make the infant eject it, and consult your physician. 	<p>Check the condition of the installation for damage.</p> <ul style="list-style-type: none"> ● After lengthy use, arrange for visit by authorized service personnel to check installation condition.
<p>Do not place animals or plants in the direct path of the air flow.</p> <ul style="list-style-type: none"> ● Lengthy exposure to direct Cooling airflow could have adverse influence on plants or animals. 	



CAUTION

Do not drink the water drained from the air conditioner.

Do not use in applications involving the storage of foods, plants or animals, precision equipment, or art works.

- The quality of the stored items may deteriorate.

Take out the batteries from the remote control unit when not using for a long time.

- Take out the batteries to prevent troubles caused by battery liquid leakage.
- If leaking battery fluid comes in contact with your skin, eyes, or mouth, immediately wash with copious amounts of water, and consult your physician.

Do not touch the heat exchanger radiator fins.

- Personal injury could result.
- Be particularly careful when cleaning.
- Bending or damage to the fins will affect the efficiency of the unit.

Always operate with the air filter installed.

- Operating the unit without the air filter could cause excessive dirt to collect on internal parts, leading to malfunction.

Do not block or cover the intake grille and outlet port.

- Obstructing the ports will reduce operating efficiency, leading to improper operation and possible damage.

Install the indoor unit and remote control unit at least one meter from any television sets or radio.

- Signal radiation could be induced into the system to give erroneous operation.

Avoid installing the air conditioner near a fireplace or other heating apparatus.

- Exposure to excessive heat could result in deformation of the outer case.

When installing the indoor unit and outdoor unit, take precautions to prevent access by infants.

- Unexpected accidents could occur.

Be sure to attach the intake grille securely.

Do not use inflammable gases near the air conditioner.

NAME AND FUNCTION OF PARTS

For details of operation, see the pages indicated by the  mark.

Indoor Unit

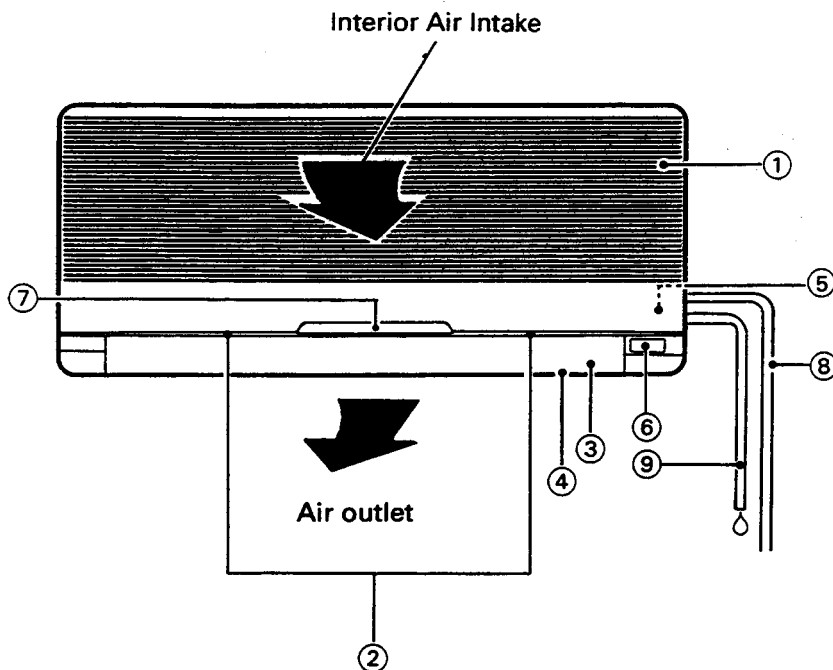

① Air Intake Grille

Air is taken in here.

② Air Filter ( P. 23)

Removes all dirt and dust from the air.

③ Flow Control Panel

Control airflow in the vertical (up-down) direction.

④ Right-left Louvers (behind Flow Control Panel)

Control airflow in the horizontal (right-left) direction.

⑤ Operating Control Panel ( P. 7)

⑥ Remote Control Signal Receiver ( P. 11)

Signals from the remote control unit are received here.

⑦ Indicator Lamps ( P. 7)

These indicator lamps show the current operating status.

⑧ Pipe Unit

⑨ Drain Hose

Moisture condensed from the air during Cooling and Drying operations is drained here.

Outdoor Unit

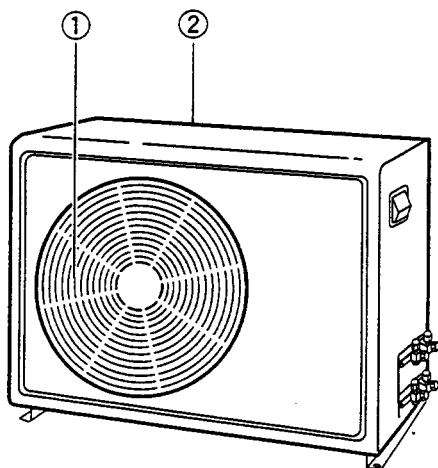

① Air outlet

Warm air is blown out.

② Air inlet

(Rear and side panels)

Indicator Lamps

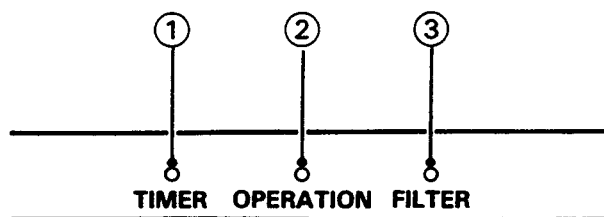

- ① **TIMER Indicator (Green)**
Lights during timer operation (☞ P. 18 to 21).
- ② **OPERATION Indicator (Red)**
 - Lights when unit is operating.
 - Flashes quickly for about one second when a signal is received from the remote control unit.
- ③ **FILTER Check Indicator (Yellow)**
Lights when it is time to clean the air filter (☞ P. 24).

OPERATION and TIMER Indicator Lamps:

- When the OPERATION indicator and TIMER indicator flash simultaneously, the POWER switch (☞ P. 7) is in the TEST position.
- When the POWER switch is in the ON position and the OPERATION indicator and TIMER indicator flash alternately, it indicates that there has been a temporary interruption in the power supply.

Operating Control Panel

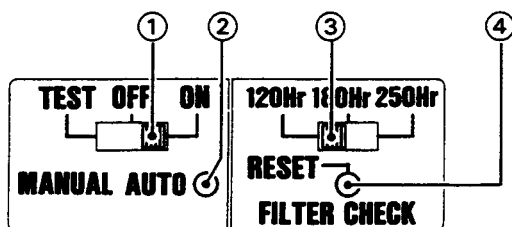

- ① **POWER switch**
 - ON:** Set to this position when using the unit.
 - OFF:** Set to this position when not using the unit for an extended period of time.
 - TEST:** Set to this position when testing after installation. Do not normally leave in this position, however, since the room temperature adjustment function will not operate.
- ② **MANUAL AUTO button**
This button can be used for temporary operation in the AUTOMATIC mode in the event the remote control unit is unavailable.
 - Press the MANUAL AUTO button**
 - Fan speed will be set to "AUTO" and the thermostat will be set to about "normal".
 - To stop operation, either press the MANUAL AUTO button once again, or set the POWER switch to OFF.
- ③ **FILTER CHECK Timer Switch**
Use to set the number of operating hours before the FILTER Check indicator lamp lights (☞ P. 24).
- ④ **FILTER RESET Button**
After cleaning the filter, press this button to reset the FILTER CHECK timer (☞ P. 24).

NAME AND FUNCTION OF PARTS

Remote Control Unit

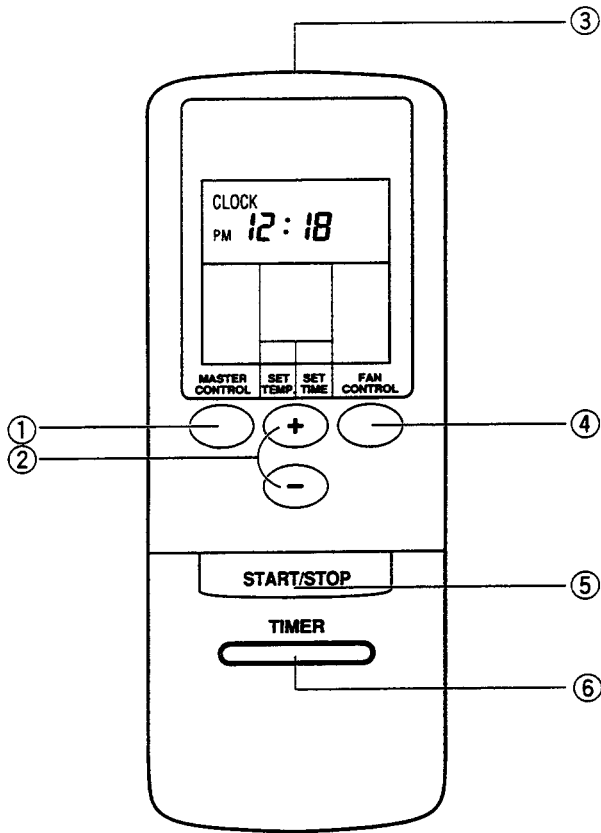

- ① **MASTER CONTROL button**
Press to select operating mode (AUTO, COOL, DRY, FAN)
- ② **SET TEMP./SET TIME buttons (+/-)**
Press to set the unit's thermostat and clock.
- ③ **Signal Transmitter**
Control signals are sent to the air conditioner from here.
- ④ **FAN CONTROL button**
Press to select fan speed. (AUTO, HIGH, MED, LOW)
- ⑤ **START/STOP button**
Press to start and stop operation.
- ⑥ **TIMER button (☞ P. 18 to 21)**
Press to select the timer mode (SLEEP TIMER, OFF TIMER, ON TIMER, PROGRAM TIMER, RESET).

Remote Control Unit (Rear Side)

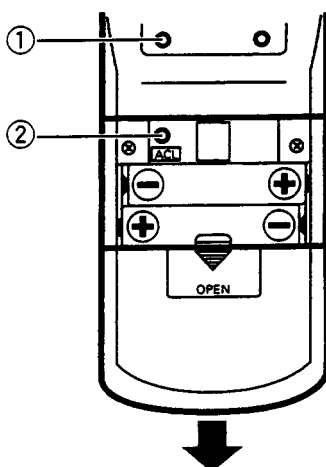

- ① **TIME ADJUST button (☞ P. 11)**
- ② **ACL button (located inside battery compartment) (☞ P. 10)**
This button is used when replacing batteries.

Remote Control Unit Display

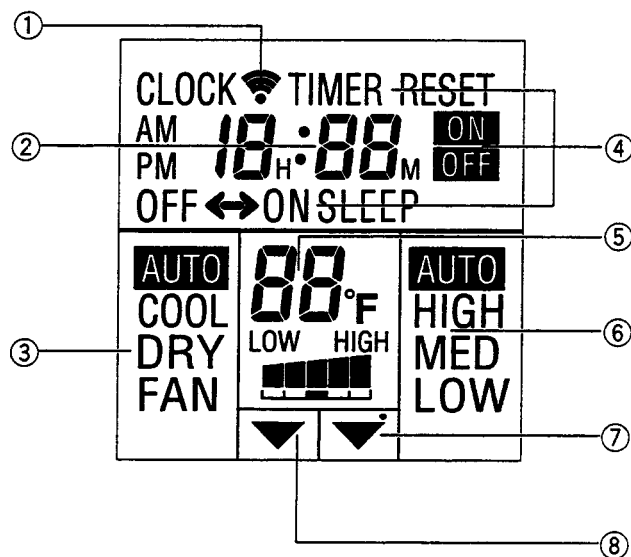

* The accompanying illustration depicts the control display with all indicators lighted; in actual use, however, only those indicators currently required are displayed.

① Transmit Indicator

This indicator is displayed when a signal is sent to the air conditioner.

② Clock Display

- When CLOCK is displayed, the current time is shown in 12-hour format (AM/PM).
- When TIMER is displayed, the timer setting is shown in 12-hour format (AM/PM).
- When SLEEP timer has been selected, the display shows the remaining time until the unit turns off (0H:05M to 9H:55M).

③ Operation Mode Display

Displays the operation mode (COOL, etc.).

④ Timer Mode Display

Displays the timer mode (OFF TIMER, ON TIMER, PROGRAM TIMER, SLEEP, RESET).

⑤ Set Temperature Display

Displays the thermostat setting.

⑥ Fan Speed Display

Displays the current fan speed.

⑦ Set Time Indicator

When this indicator is flashing, the \odot/\ominus buttons can be used to set the time (TIME set mode).

⑧ Set Temperature Indicator

When this indicator is flashing, the \odot/\ominus buttons can be used to set the thermostat (TEMPERATURE set mode).

- Signals will not be transmitted properly if a wall, curtain, or other object is between the air conditioner and the remote control unit.
- The air conditioner may fail to operate properly if strong direct light is allowed to strike the signal receiver. Use a curtain to shade strong sunlight from windows, and place strong lamps at a distance away from the signal receiver.
- If another electric appliance is operated by the remote control unit move the appliance away or consult with authorized service personnel.

- Do not place the remote control unit in locations where it may be subjected to heat from direct sunlight or from heating apparatus.
- Do not subject the remote control unit to strong impacts, and do not allow water or other liquids to splash on it.
- When the remote control unit is used in rooms furnished with instant-lighting type fluorescent lamps, the air conditioner may fail to receive control signals correctly. Consult with authorized service personnel when purchasing a new fluorescent lamp.

PREPARATION

Turn on the Power

- 1 Turn on the Power.

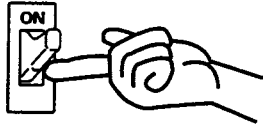

In the case of direct line connections, turn on the breaker.

- 2 Open the Intake Grille.

- 3 Set the POWER switch to ON.

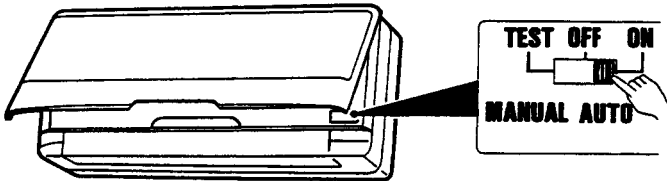

- 4 Close the Intake Grille.

Opening/closing the Intake Grille

- ① Place your fingers on either side of the intake grille, then pull outward until the grille reaches the first stop (the intake grille will remain open even if you remove your hands).

- If the grille is pulled out further, it can be removed (see P. 23)

Do not operate the unit with the intake grille open, since malfunctions may result.

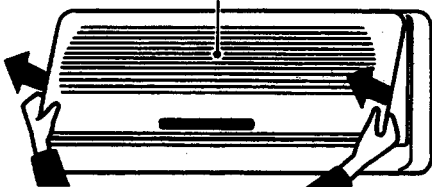

- ② Press the lower sides of the intake grille to close it again.

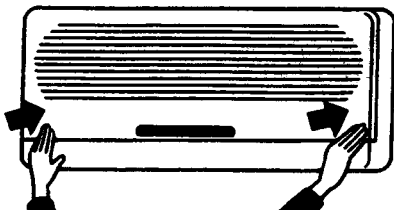



Prepare the Remote Control Unit

Load batteries in the remote control unit and set the clock to the current time.

Load Batteries (AAA R03/LR03 x 2)

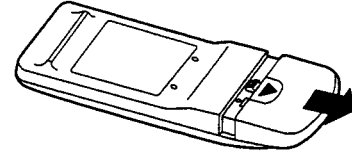
- 1 Press and slide the battery compartment lid on the reverse side to open it.



Slide in the direction of the arrow while pressing the  mark.

- 2 Insert batteries.

Be sure to align the battery polarities (+/-) correctly.

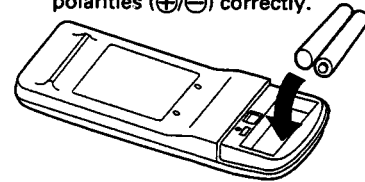

- 3 Close the battery compartment lid.

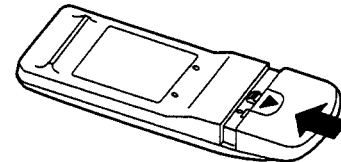

CAUTION!

- Take precautions to prevent infants from accidentally swallowing batteries.
- When not using the remote control unit for an extended period, remove the batteries to avoid possible leakage and damage to the unit.
- * If leaking battery fluid comes in contact with your skin, eyes, or mouth, immediately wash with copious amounts of water, and consult your physician.
- Dead batteries should be removed quickly and disposed of properly, either by placing in a public battery collection receptacle, or by returning to a properly equipped dealer.
- Do not attempt to recharge dry batteries.

NOTE:

- Never mix new and used batteries, or batteries of different types.
- Batteries should last about one year under normal use. If the remote control unit's operating range becomes appreciably reduced, replace the batteries and press the ACL button with the tip of a ballpoint pen or other small object.

Set the Current Time

1 Press the TIME ADJUST button.

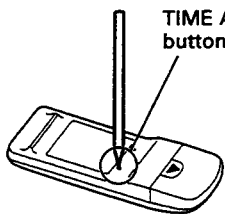

(Rear Side)

Use the tip of a ball-point pen or other small object to press the button.

<Remote Control Unit Display>

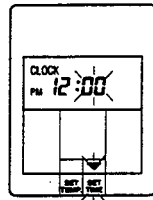

The time display and time set mark ▼ will flash.

2 Use the (+/-) TIME SET buttons to adjust the clock to the current time.

- ⊕ button: Press to advance the time.
- ⊖ button: Press to reverse the time.

(Each time the buttons are pressed, the time will be advanced/reversed in one-minute increments; hold the buttons depressed to change the time quickly in ten-minute increments).

Example:
When the clock is set to 9:53 P.M.

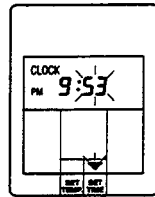

3 Press the TIME ADJUST button again.

This completes the time setting and starts the clock.

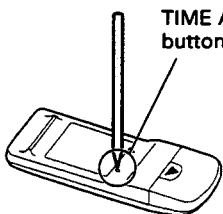

(Rear Side)

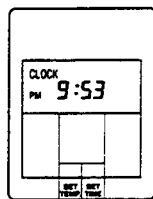

The time display stops flashing and lights steadily. The time set mark ▼ will disappear.

To Use the Remote Control Unit

- The remote control unit must be pointed at signal receiver to operate correctly.
- When a signal is properly received by the air conditioner, a beeping sound will be heard.
- If no beep is heard, press the remote control unit button again.

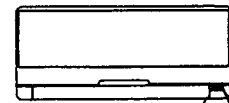

Signal Receiver



Operating Range:
Within about 7 meters

Remote Control Unit Holder

- This holder can be mounted on a wall or in a convenient position to allow operation.
- If the holder is installed in a location allowing signals to be received by the air conditioner, the remote control unit can be used without removing it from the holder.

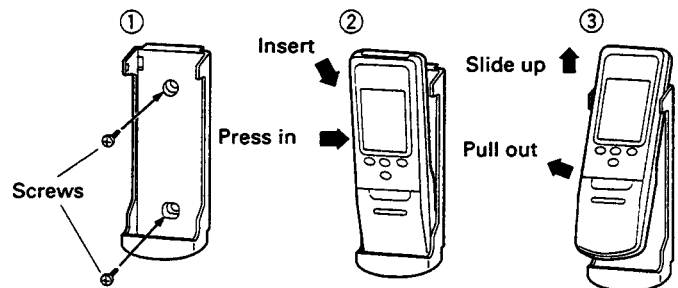

- ① Mount the Holder.
- ② Set the remote control unit.
- ③ To remove the remote control unit (for hand use).

AUTOMATIC OPERATION

To Select AUTOMATIC Operation

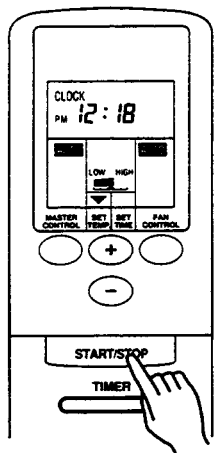

1 Press the START/STOP button.

The air conditioner will start operation.

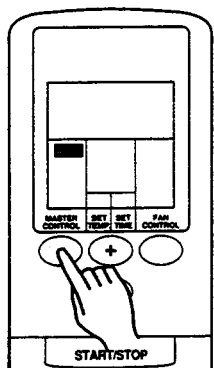

2 Press the MASTER CONTROL button to select AUTO.

The operating mode "AUTO" will appear alone in the display. The transmit indicator will flash to indicate the command has been sent, and about three seconds later the entire display panel will reappear.

About AUTOMATIC Operation

- Depending on the room temperature at the time operation begins, the operating mode will be switched automatically as shown in the accompanying table. Also, depending on the operating mode, the room temperature setting will cause the "normal" temperature to be set as shown.

- Once the operating mode has been set, the mode will not change even if the room temperature changes.
- In the dry mode, the fan will operate slowly to prevent room humidity from rising, and the room fan may stop.

Room Temperature	Operating Mode	Temperature Setting ("normal" setting)
88°F or more	⇒ Cooling	⇒ 82°F
82°F to 88°F	⇒ Cooling	⇒ 80°F
78°F to 82°F	⇒ Dry	⇒ 76°F
74°F to 78°F	⇒ Dry	⇒ 72°F
Less than 74°F	⇒ Dry	⇒ 68°F

To Set the Thermostat

Press the **TEMPERATURE** set button.

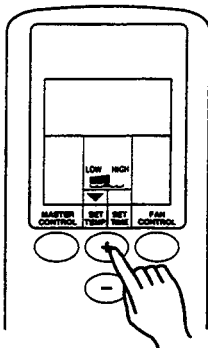

Example: When set to "normal".



When set to
4°F lower

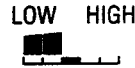

When set to
2°F lower

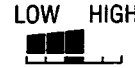

When set to
"normal"

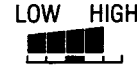

When set to
2°F higher



When set to
4°F higher

About three seconds later, the entire display will reappear.

NOTE: The thermostat setting should be considered a standard value, and may differ somewhat from the actual room temperature.

To Change the Fan Speed

Press the **FAN CONTROL** button.

Each time the button is pressed, the fan speed changes in the following order:

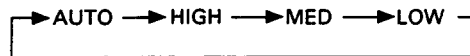

About three seconds later, the entire display will reappear.

When the **FAN CONTROL** is set to **AUTO**:

COOL: Operation begins and as the room temperature approaches that of the thermostat setting, the fan speed switches to the low setting.

As the difference between the thermostat setting and actual room temperature is reduced, the fan speed becomes slower.

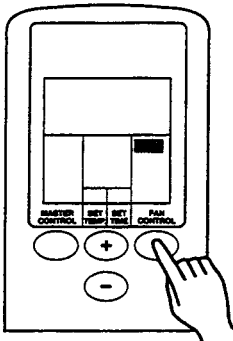

Example: When set to AUTO.

To Stop Operation

Press the **START/STOP** button.

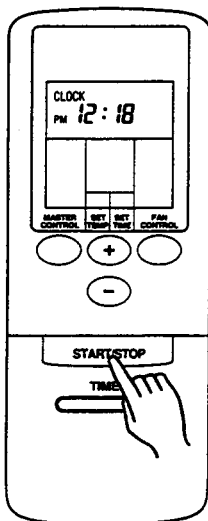

MODE OPERATION (COOL, DRY, FAN)

To Select Mode Operation

1 Press the START/STOP button.

The air conditioner will start operation.

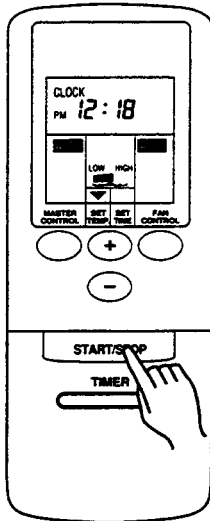

2 Press the MASTER CONTROL button to select the desired mode.

Each time the button is pressed, the mode will change in the following order:

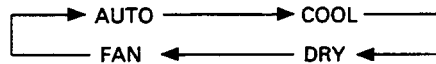

About three seconds later, the entire display will reappear.

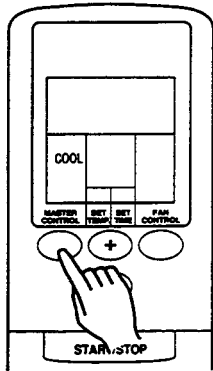

Example: When set to COOL.

About Mode Operation

Cooling

- Use to cool your room.

Drying

- Use for gently cooling while dehumidifying your room.
- You cannot heat the room during Drying mode.
- During Drying mode, the unit will operate at low speed; in order to adjust room humidity, the indoor unit's fan may stop from time to time. Also, the fan may operate at very low speed when detecting room humidity.
- The fan speed cannot be changed manually when Drying mode has been selected.

Fan

- When using a space heater to heat the room, using the air conditioner's Fan setting will help prevent warm air from collecting near the ceiling, and thus assist in distributing warm air evenly throughout the room.
- Fan operation will begin automatically when the room temperature rises above the set temperature, and stop when the temperature falls below the set temperature.
- If the air emitted from the unit feels too cold, increase the temperature setting.

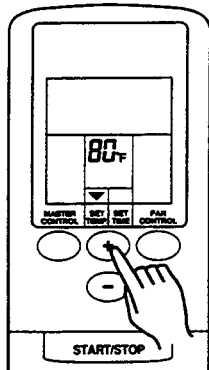

Example: When set to 80°F.

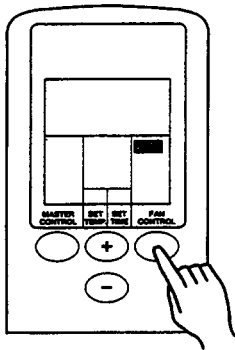

Example: When set to AUTO.

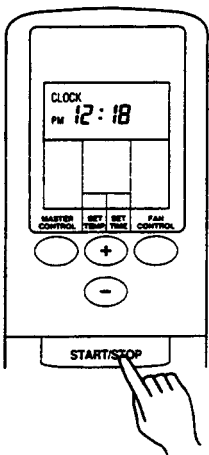

To Set the Thermostat

Press the TEMPERATURE set button.

- ⊕ button: Press to increase the thermostat setting.
- ⊖ button: Press to lower the thermostat setting.

● Thermostat setting range:

Cooling/Drying 64°F to 88°F
 Fan 62°F to 88°F

About three seconds later, the entire display will reappear.

NOTE:

- The thermostat setting should be considered a standard value, and may differ somewhat from the actual room temperature.
- During Fan mode, set the unit to "--" for continuous fan operation regardless of room temperature.

To Set the Fan Speed

Press the FAN CONTROL button.

Each time the button is pressed, the fan speed changes in the following order:

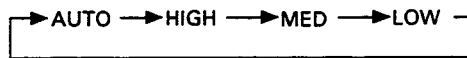

About three seconds later, the entire display will reappear.

When set to AUTO:

Cooling: Operation begins and as the room temperature approaches that of the thermostat setting, the fan speed switches to the low setting.

Fan: Fan speed is selected automatically in accordance with nearby room temperature.

To Stop Operation

Press the START/STOP button.

● During Cooling/Drying mode:

Set the thermostat to a temperature setting that is lower than the current room temperature. The Cooling and Drying modes will not operate if the thermostat is set higher than the actual room temperature (in Cooling mode, the fan alone will operate).

● During Fan mode:

You cannot use the unit to cool your room.

AIR DIRECTION ADJUSTMENT

Adjust the air direction in accordance with the mode selected.



WARNING

- Do not put fingers or other objects into the air louvers; an internal fan operates at high speed and could result in personal injury or damage.
- Do not operate the air conditioner with the airflow louvers blocked, since malfunction could result.

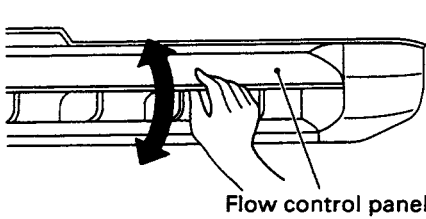

Vertical Adjustment (Use the Flow Control Panel)

Moving the flow control panel

During Cooling/Drying operation:

- Set the flow control panel upward to allow cool air to circulate throughout the room.

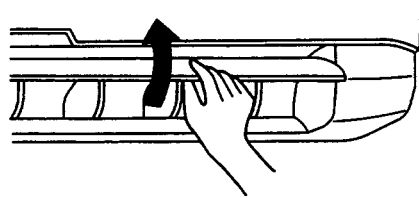

During FAN operation:

- Set the flow control panel as desired.

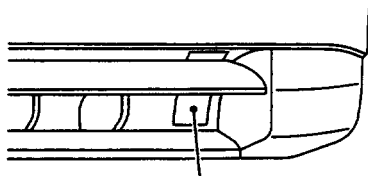
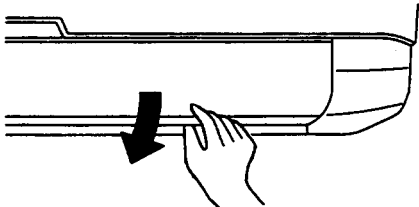

About the Air-Direction Range Label

- The blue colour indicates the range for Cooling and Drying.



CAUTION

- In the Cooling and Drying modes, dew may condense around and drop from the air outlet ports when the louvers are set to the Fan range. As a result, we recommend that this position be used only for brief periods.
- When used in a room with infants, elderly or sick persons, the air direction and room temperature should be considered carefully when making settings.

Adjusting the Right-Left Direction

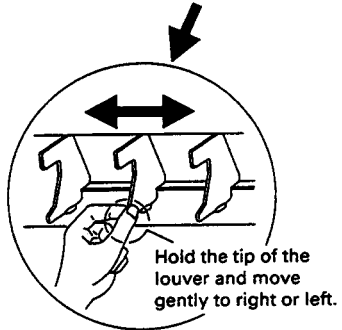
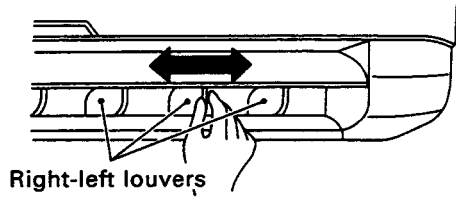

Adjust with the right-left louvers

- Manually adjust the right-left louvers to the desired direction.

TIMER OPERATION

Before using the timer function, be sure that the remote control unit is set to the correct current time (see P. 11).

OFF TIMER (Stops the air conditioner operation at the set time)

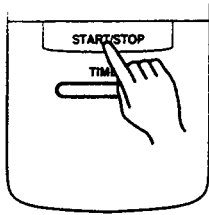

- 1 Press the START/STOP button (if the unit is already operating, proceed to step 2).**

The indoor unit's red OPERATION lamp will light.

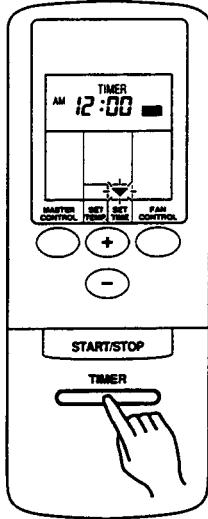

- 2 Press the TIMER button to select the OFF timer operation.**

Each time the button is pressed the timer function changes in the following order:

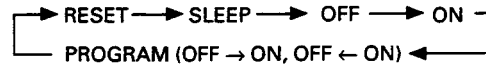

The indoor unit's green TIMER lamp will light.

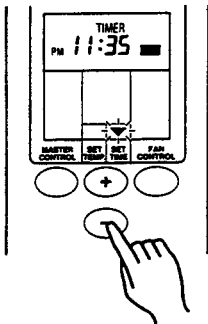

- 3 Use the SET TIME buttons to adjust the desired OFF time.**

Set the time while the time display is flashing (the flashing will continue about five seconds).

- + button:** Press to advance the time.
- button:** Press to reverse the time.

About three seconds later, the entire display will reappear.

Example: When set to turn off at 11:35 P.M.

To Cancel the Timer

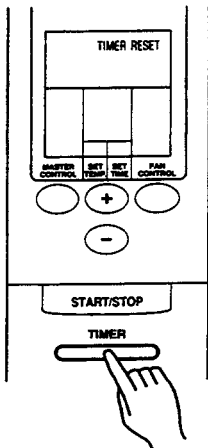

Use the TIMER button to select "RESET".
The air conditioner will return to normal operation.

To Change the Timer Setting

Perform steps 2 and 3.

ON TIMER (Begins air conditioner operation at the set time)

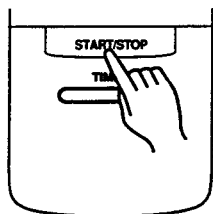

- 1 Press the START/STOP button (if the unit is already operating, proceed to step 2).**

The indoor unit's red OPERATION lamp will light.

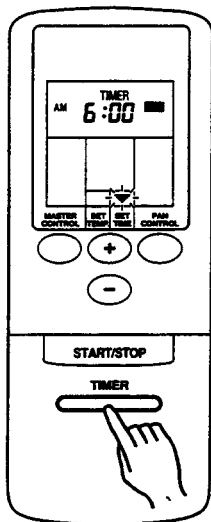

- 2 Press the TIMER button to select the ON timer operation.**

Each time the button is pressed the timer function changes in the following order:

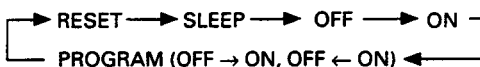

The indoor unit's green TIMER lamp will light.

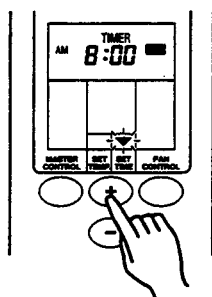

- 3 Use the SET TIME buttons to adjust the desired ON time.**

Set the time while the time display is flashing (the flashing will continue about five seconds).

+ button: Press to advance the time.

- button: Press to reverse the time.

About three seconds later, the entire display will reappear.

Example: When set to turn on at 8:00 A.M.

To Stop Air Conditioner Operation while the Timer is Operating

Press the START/STOP button.

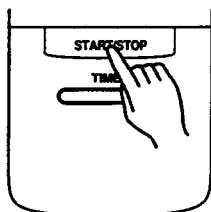

To Change Operating Conditions

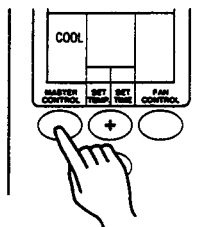

Example: To select COOL mode.

If you wish to change operating conditions (Mode, Fan Speed, Thermostat Setting), after making the timer setting wait until the entire display reappears, then press the appropriate buttons to change the operating condition desired.

PROGRAM TIMER

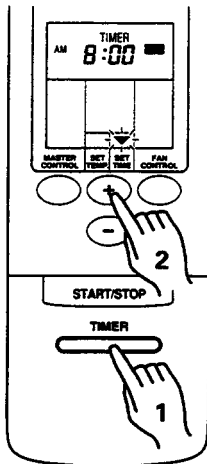
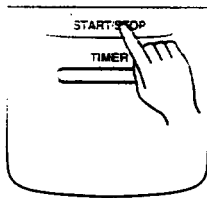

Example: When ON timer is set for 8:00 A.M.

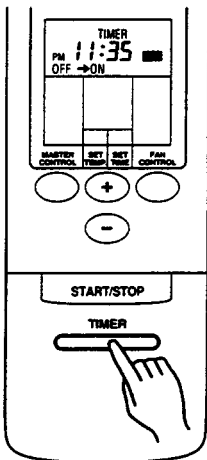

Example: When set to turn off at 11:35 P.M. and turn on at 8:00 A.M.

To Use the Program Timer

1 Press the START/STOP button (if the unit is already operating, proceed to step 2).

The indoor unit's red OPERATION lamp will light.

2 Set the desired times for OFF timer and ON timer.

See steps 2 and 3 on pages 18 and 19 to set the desired mode and times.

About three seconds later, the entire display will reappear.

The indoor unit's green TIMER lamp will light.

3 Press the TIMER button to select the PROGRAM Timer operation (OFF → ON or OFF ← ON will display).

The display will alternately show "OFF timer" and "ON timer", then change to show the time setting for the operation to occur first.

- The program timer will begin operation. (If the ON timer has been selected to operate first, the unit will stop operating at this point).

About three seconds later, the entire display will reappear.

About the Program Timer

- The program timer allows you to integrate OFF timer and ON timer operations in a single sequence. The sequence can involve one transition from OFF timer to ON timer, or from ON timer to OFF timer, within a twenty-four hour period.
- The first timer function to operate will be the one set nearest to the current time. The order of operation is indicated by the arrow in the remote control unit's display (OFF → ON, or OFF ← ON).
- One example of program timer use might be to have the air conditioner automatically stop (OFF timer) after you go to sleep, then start (ON timer) automatically in the morning before you arise.

To Cancel the Timer

See page 18.

To Stop Air Conditioner Operation while the Timer is Operating

See page 19.

To Change the Timer Settings

1. Follow steps 2 and 3 on page 18 to 19 to select the timer setting you wish to change.
2. Press the TIMER button to select either OFF → ON or OFF ← ON.

To Change Operating Conditions

See page 19.

SLEEP TIMER OPERATION

Unlike other timer functions, the SLEEP timer is used to set the length of time until air conditioner operation is stopped (for example, 2:00 hours).

To Use the SLEEP Timer

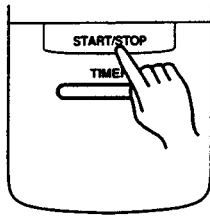

- 1 Press the START/STOP button (if the unit is already operating, proceed to step 2).**

The indoor unit's red OPERATION lamp will light.

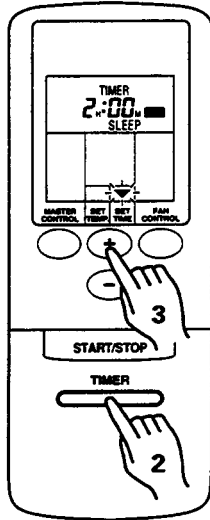

- 2 Press the TIMER button to select the SLEEP timer operation.**

Each time the button is pressed the timer function changes in the following order:

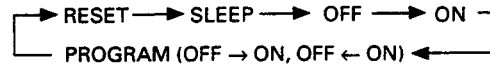

The indoor unit's green TIMER lamp will light.

- 3 Use the SET TIME buttons to adjust the desired OFF time.**

Set the time while the time display is flashing (the flashing will continue about five seconds).

- + button:** Press to advance the time.
- button:** Press to reverse the time.

About three seconds later, the entire display will reappear.

Example: When set to turn off two hours from the present time.

To Cancel the Timer:

See page 18.

To Stop the Air Conditioner During Timer Operation:

See page 19.

About the SLEEP Timer

To prevent excessive cooling during sleep, the SLEEP timer function automatically modifies the thermostat setting in accordance with the time setting. When the set time has elapsed, the air conditioner completely stops.

During Cooling/Drying operation:

When the SLEEP timer is set, the thermostat setting is automatically raised 2°F every sixty minutes. When the thermostat has been raised a total of 4°F, the thermostat setting at that time is maintained until the set time has elapsed, at which time the air conditioner automatically turns off.

SLEEP timer setting

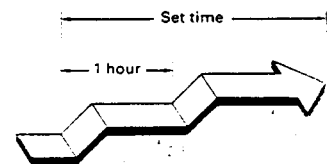



WARNING

Before cleaning the unit, be sure to stop the unit and disconnect the power.

1. Disconnect the power.
 2. Turn off the electrical breaker.
- A fan operates at high speed inside the unit, and personal injury could result.

When cleaning the air conditioner, turn off the electrical breaker.

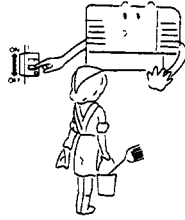

Never use water that is hotter than 100°F. The body may warp or change color.



The unit can be damaged by gasoline, benzine, thinners, insecticides and other chemical agents.

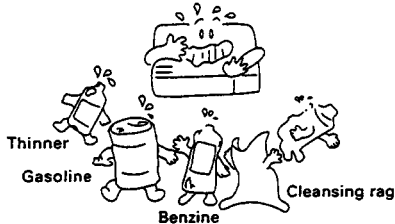

Do not use inflammable sprays such as lacquer or hair spray near the air conditioner.

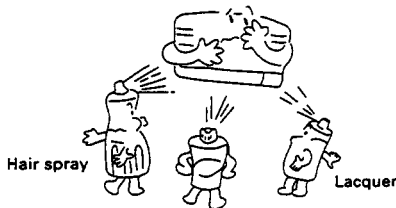

Cleaning the Indoor Unit

Clean the indoor unit by wiping with a cloth dipped in cool or warm water, then wipe with another soft, clear dry cloth.

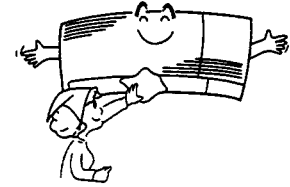

When Not Using the Unit for Extended Periods (One Month or More)

Operate the unit on fan mode for about one-half day on a day with clear weather, to assure that the internal parts are dry (see p. 14).



CAUTION

When not using the unit for extended periods, disconnect the power for safety.

Inspections and Repairs

Depending on the conditions of use, the internal parts of an air conditioner will become dirty after about two or three seasons of use, and performance may be affected. For this reason, regular professional maintenance is recommended. Consult authorized service personnel.

Cleaning the Intake Grille

Removing the Intake Grille

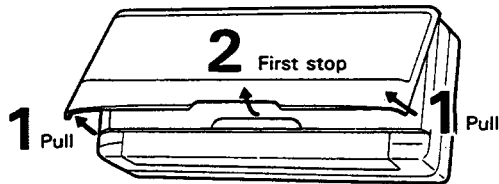

1. Place your fingers on either side of the intake grille, then pull outward. Although the grille will reach a first stop, pull it out even further to remove it.
2. Lift the intake grille upward.

Cleaning the Intake Grille

Use a vacuum cleaner to remove dust accumulations, then wipe the grille with a clean cloth dipped in warm water; wipe with a clean dry cloth to remove any water.

Installing the Intake Grille

Align the intake grille three tabs with their respective indentations on the indoor unit, and press the sides of the grille downward to return it to its original position.

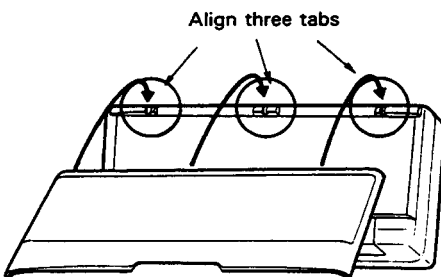

CAUTION!

- Be careful not to drop the intake grille.
- Do not operate the unit with the intake grille open, since malfunctions may result.

Cleaning the Air Filter

When the air filter becomes clogged with dust, the air flow will be reduced and operating noises may increase. Clean the filter when the FILTER Check indicator lamp begins to light or flash.

Removing the Air Filter

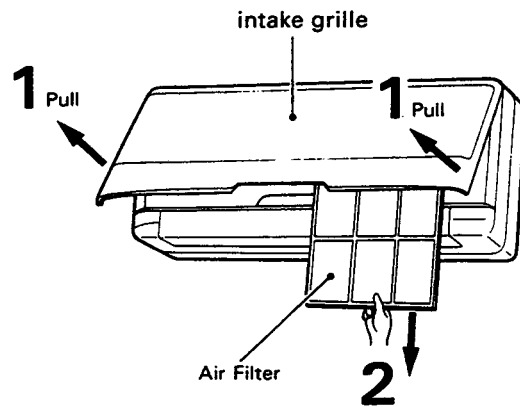

1. Place your fingers on either side of the intake grille, then pull outward until the cover reaches the first stop (see P.10). The intake grille will remain open even if you remove your hands.
2. Grasp the handle of the air filter and pull down.

Cleaning the Air Filter

Either use a vacuum cleaner to remove accumulated dust, or wash in a neutral detergent solution. When washing the filter, allow it to dry well in a shaded location before reinstalling it in the air conditioner.

- After cleaning, replace the filter in its original location, and press the FILTER RESET button (see P.24).
- To close the intake grille, press the lower sides of the grille until it closes fully.

CARE AND MAINTENANCE

About the FILTER Check indicator lamp

The FILTER Check indicator lamp will light after the accumulated times noted in the accompanying table, indicating that it is time to clean the filter.

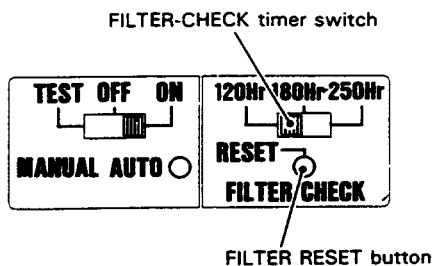

FILTER CHECK timer switch setting	FILTER Check indicator lamp	
	Lights steadily	Flashes
120 Hr	After 120 hours of operation	After 150 hours of operation
180 Hr	After 180 hours of operation	After 220 hours of operation
250 Hr	After 250 hours of operation	After 300 hours of operation

About the FILTER CHECK timer switch

Set the switch in accordance with the surrounding room conditions:

- In dusty locations: 120 hours
- In dust-free locations: 250 hours

About the FILTER RESET button

Press the FILTER RESET button after cleaning the air filter. (The total operating time noted above will become 0 and the FILTER Check indicator lamp will go out.)

NOTE:

- If the power is disconnected or a power failure occurs, the timer will be reset to "0". When the unit is then operated again, the FILTER Check indicator lamp will begin flashing.
- In this event, check the condition of the filter and then press the FILTER RESET button.

OPERATION DETAILS

Please read and understand the following details regarding this air conditioner.

Malfunction

Nearby lightning or use of a mobile radio (short wave, etc.) may result in malfunction. In this case, disconnect the power plug from its outlet and connect it again, then use the remote control unit to resume operation.

Temperature and Humidity Range

Permissible ranges of temperature and humidity are as follows:

Cooling Operation	Outdoor temperature: About 70°F to 115°F
	Indoor temperature: About 65°F to 90°F
	Indoor humidity: About 80% or less. If the unit is used for long periods under conditions of high humidity, water may condense on and drip from the surface of the unit.
Drying Operation	Outdoor temperature: About 70°F to 115°F
	Indoor temperature: About 65°F to 90°F
	Indoor humidity: If the unit is used for long periods under conditions of high humidity, water may condense on and drip from the surface of the unit.

If the unit is used under higher temperature conditions than those noted here, the automatic protection circuit may operate, interrupting the operation.

- Do not use the air conditioner for any purpose other than room cooling, room drying or fan.





TROUBLESHOOTING



WARNING!

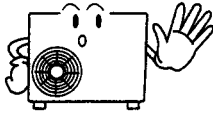

in the event of a malfunction (burning smell, etc.), immediately stop operation, disconnect the power, and consult authorized service personnel.
 Merely turning off the unit's power switch will not completely disconnect the unit from the power source. Always be sure to disconnect the power and turn off your circuit breaker to ensure that power is completely off.

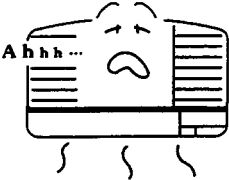
Before requesting service, perform the following checks:

	Symptom	Problem	See Page
NORMAL FUNCTIONS	Doesn't operate immediately: 	<ul style="list-style-type: none"> ● If the unit is stopped and then immediately started again, the compressor will not operate for about 3 minutes, in order to prevent fuse blowouts. ● Whenever the power is disconnected and then reconnected, the protection circuit will operate for about 3 minutes, preventing unit operation during that period. 	—
	Noise is heard: 	<ul style="list-style-type: none"> ● During operation and immediately after stopping the unit, the sound of water flowing in the air conditioner's piping may be heard. Also, noise may be particularly noticeable for about 2 to 3 minutes after starting operation (sound of coolant flowing). ● During operation, a slight squeaking sound may be heard. This is the result of minute expansion and contraction of the front cover due to temperature changes. 	—
	Smells: 	<ul style="list-style-type: none"> ● Some smell may be emitted from the indoor unit. This smell is the result of room smells (furniture, tobacco, etc.) which have been taken into the air conditioner. 	—
	Mist or steam are emitted: 	<ul style="list-style-type: none"> ● During Cooling or Drying operation, a thin mist may be seen emitted from the indoor unit. This results from the sudden Cooling of room air by the air emitted from the air conditioner, resulting in condensation and misting. 	—
	Airflow is weak or stops. 	<ul style="list-style-type: none"> ● The fan may operate at very low speed during Drying mode or when the unit is monitoring the room's temperature. ● In the monitor AUTO operation, the fan will operate at very low speed. 	14

**WARNING**

Consult authorized service personnel for any repairs.

	Symptom	Items to Check	See Page
CHECK ONCE MORE	Doesn't operate at all: 	<ul style="list-style-type: none"> ● Has there been a power failure? ● Has a fuse blown out, or a circuit breaker been tripped? 	—
		<ul style="list-style-type: none"> ● Is the main power switch set to the OFF position? 	10
		<ul style="list-style-type: none"> ● Is the timer operating? 	18 to 21
	Poor Cooling performance: 	<ul style="list-style-type: none"> ● Is the air filter dirty? ● Are the air conditioner's intake grille or outlet port blocked? ● Did you adjust the room temperature settings (thermostat) correctly ? ● Is there a window or door open? ● In the case of cooling operation, is a window allowing bright sunlight to enter? (Close the curtains.) ● In the case of Cooling operation, are there heating apparatus or computers inside the room, or are there too many people in the room? 	—

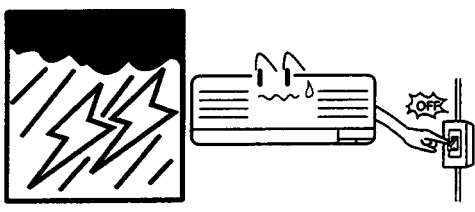
In event of power failure 	When POWER switch (P. 7) is set to ON:	See Page
	<ul style="list-style-type: none"> ● If a power failure occurs during operation, all operations will stop (any current timer setting will also be erased). To begin operation again, use the remote control unit normally after power is restored. ● If the electrical breaker is turned off and after power is restored, or after being temporarily interrupted, the red OPERATION lamp will flash alternately with the green TIMER lamp (these lamps will not flash if the indoor unit's main POWER switch is set to OFF). When the remote control unit is used to begin operation again, the lamps will stop flashing. 	—
	<ul style="list-style-type: none"> ● In the event that malfunction occurs as the result of a nearby lightning strike or signal from mobile communications equipment, turn off the electrical breaker and then on again, and use the remote control unit normally. 	—



FUJITSU GENERAL AMERICA, INC.
353 ROUTE 46W., FAIRFIELD, N.J. 07004
Tel. (973) 575-0380