

Fan speed : High

Operating mode : Fan

Voltage : 115V-60Hz

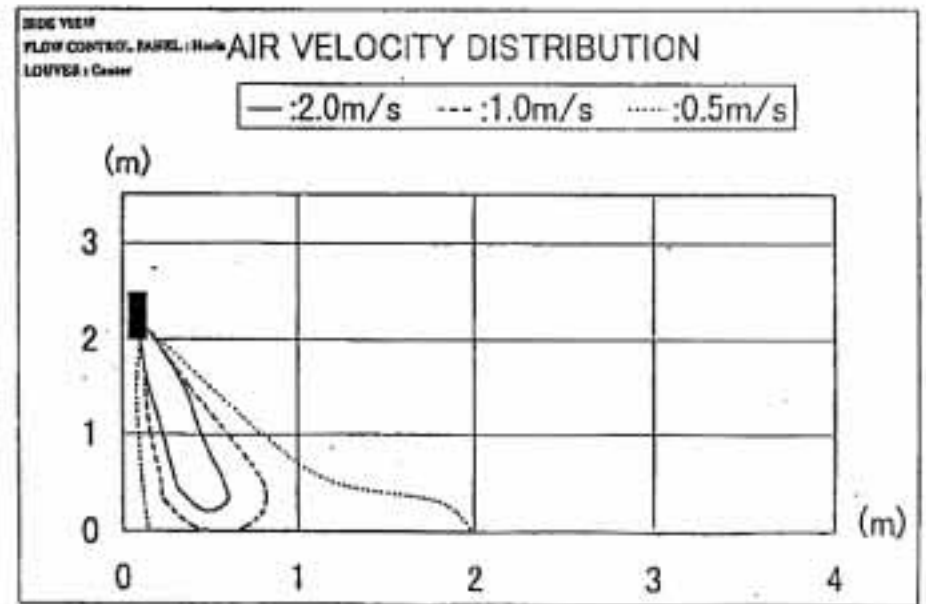
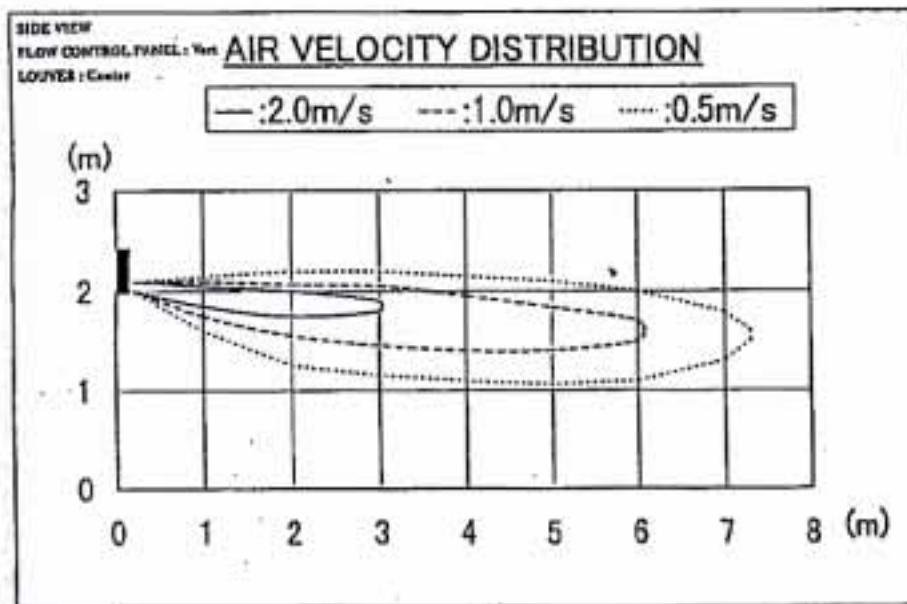

Models: 18C1 & 18R1

TOP VIEW
 FLOW CONTROL PANEL : Horiz
 LOUVER : Center

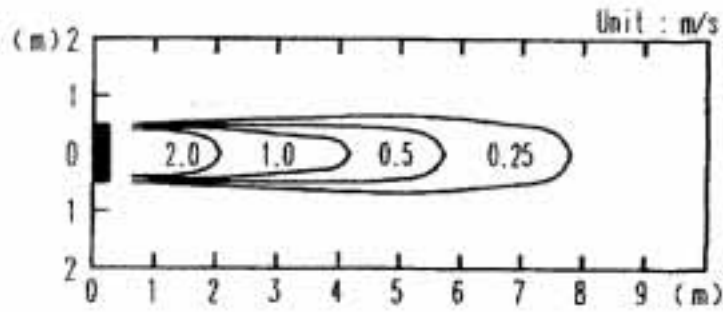

TOP VIEW
 FLOW CONTROL PANEL : Horiz
 LOUVER : Right & Left

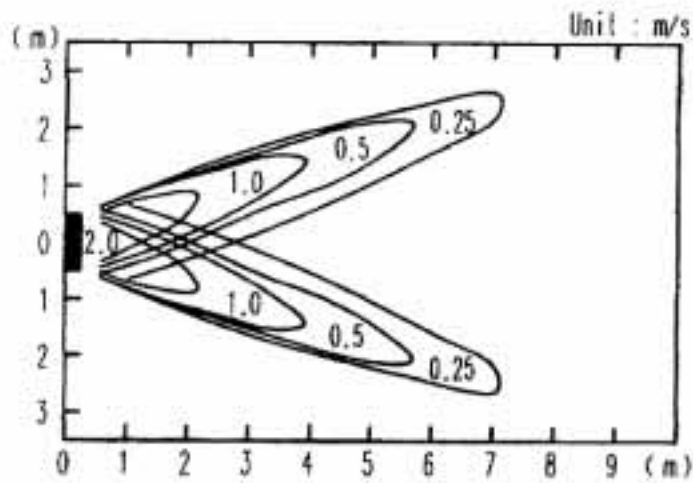

SIDE VIEW
 FLOW CONTROL PANEL : Horiz
 LOUVER : Center

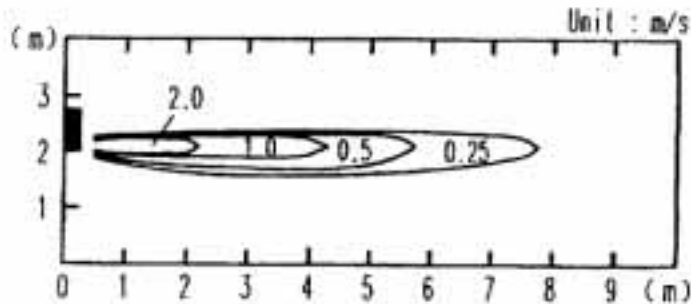

SIDE VIEW
 FLOW CONTROL PANEL : Vert
 LOUVER : Center

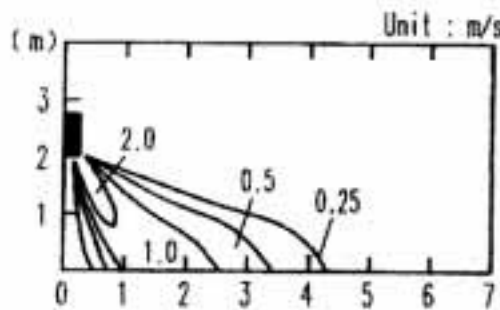

Condition
Fan Speed : High
Operation mode : Fan
Voltage : 230 V

Models: 24C1, 24R1, 30C1

TOP VIEW
 FLOW CONTROL PANEL : Horiz
 LOUVER : Center

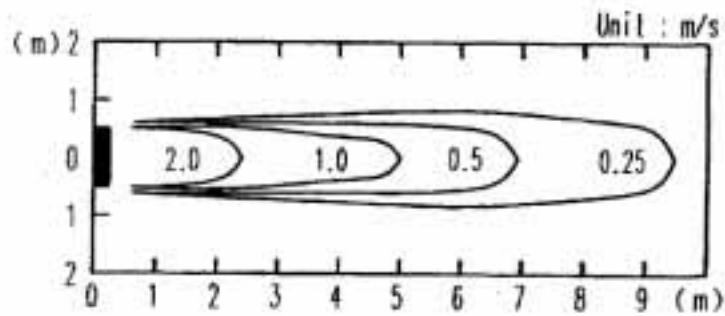

TOP VIEW
 FLOW CONTROL PANEL : Horiz
 LOUVER : Right & Left

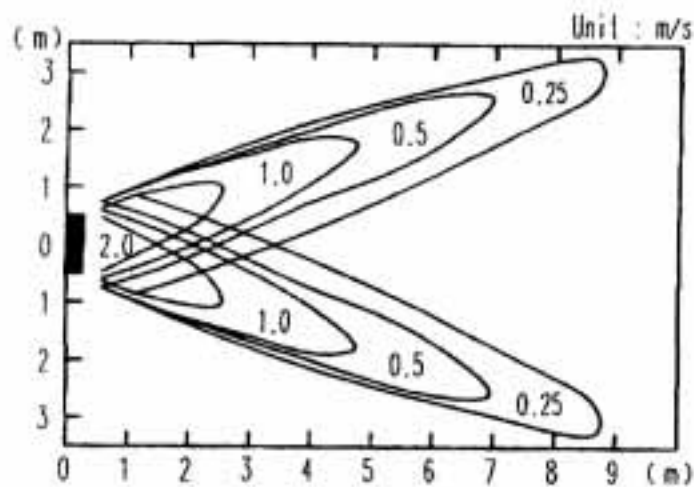

SIDE VIEW
 FLOW CONTROL PANEL : Horiz
 LOUVER : Center

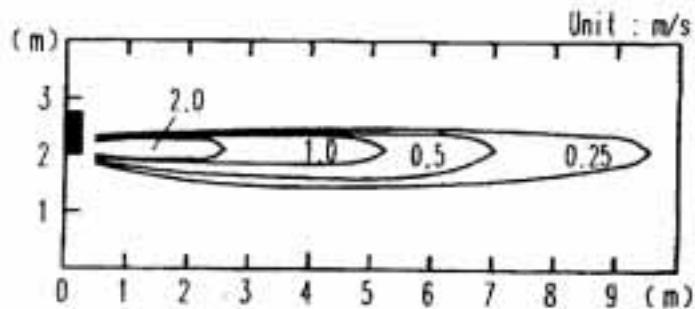

SIDE VIEW
 FLOW CONTROL PANEL : Vert
 LOUVER : Center

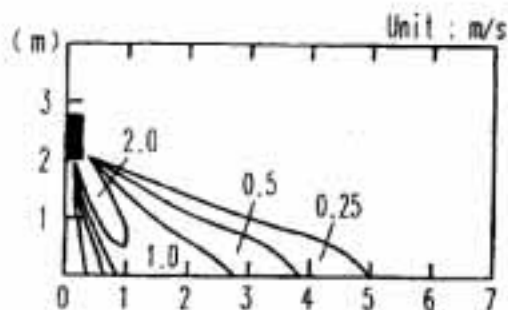

Condition
Fan Speed : High
Operation mode : Fan
Voltage : 230 V

Model: 22U UNDER CEILING

TOP VIEW
VERTICAL : Upward
HORIZONTAL : Center

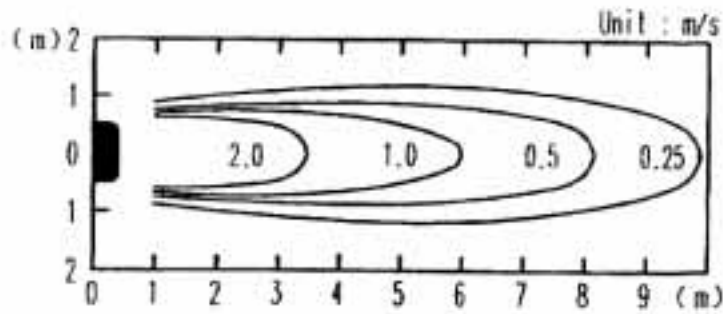

TOP VIEW
VERTICAL : Upward
HORIZONTAL : Right & Left

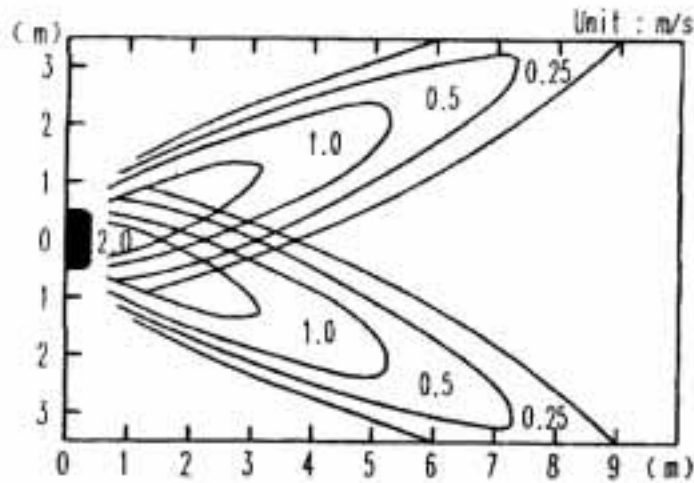

Condition
Fan Speed : High
Operation mode : Fan
Voltage : 230 V

SIDE VIEW
VERTICAL : Upward
HORIZONTAL : Center

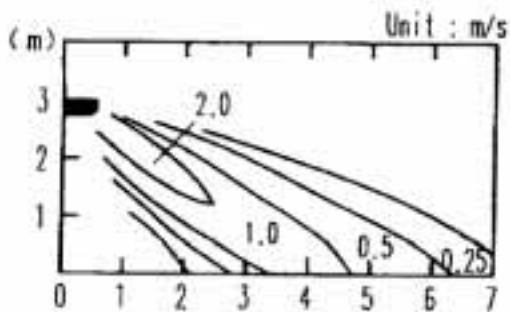
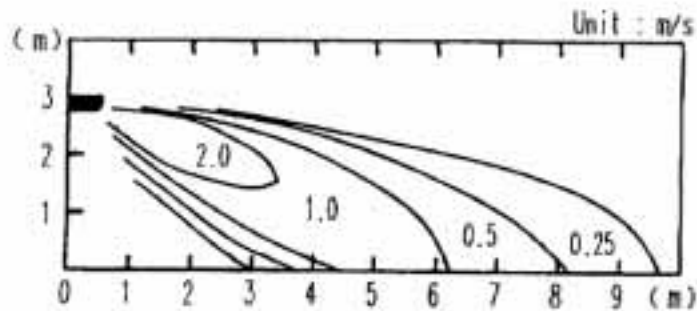

SIDE VIEW
VERTICAL : Center
HORIZONTAL : Center

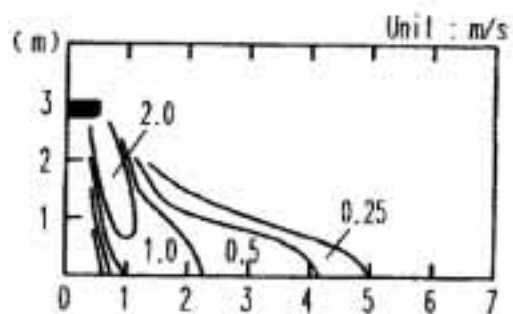

SIDE VIEW
VERTICAL : Downward
HORIZONTAL : Center

Model: 22U FLOOR CONSOLE

TOP VIEW
VERTICAL : Forward
HORIZONTAL : Center

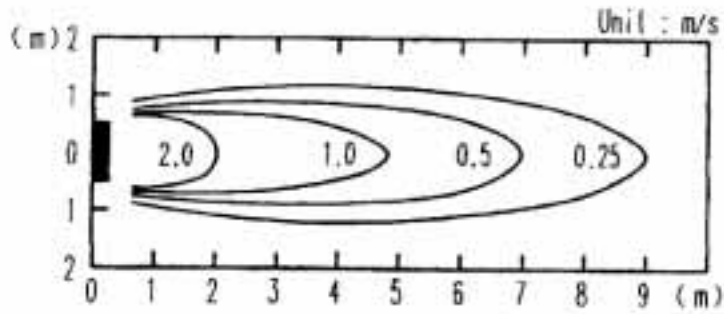

TOP VIEW
VERTICAL : Forward
HORIZONTAL : Right & Left

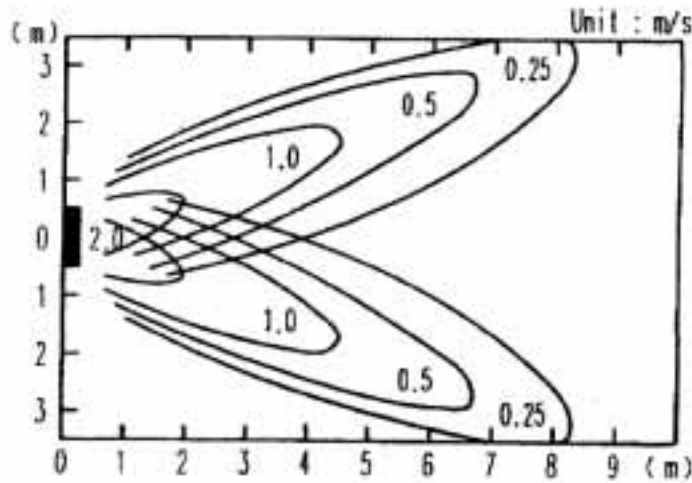

Condition
Fan Speed : High
Operation mode : Fan
Voltage : 230 V

SIDE VIEW
VERTICAL : Forward
HORIZONTAL : Center

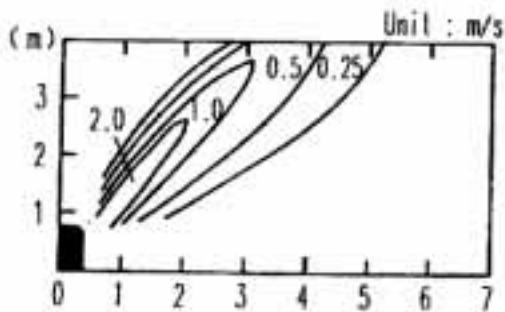
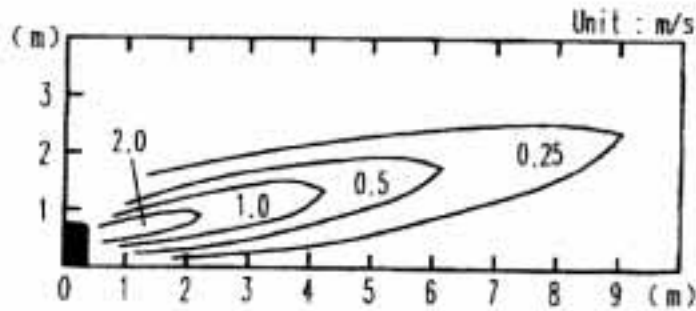

SIDE VIEW
VERTICAL : Center
HORIZONTAL : Center

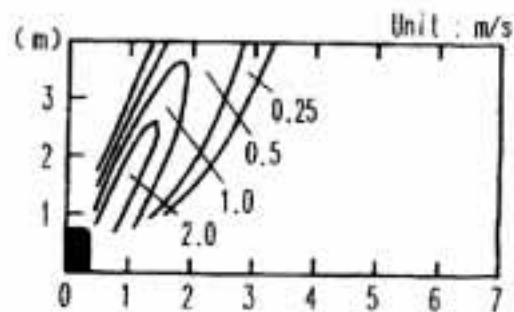

SIDE VIEW
VERTICAL : Upward
HORIZONTAL : Center